



ISE, Inc

10100 Royalton Rd.

Cleveland, OH 44133

Tel: (440) 237-3200

Fax: (440) 237-1744 <http://iseinc.com>

Tower

True On Line Double Conversion UPS

User's Manual

1KVA/2KVA/3KVA

Table of Contents

Important Safety Instructions

- An Important Notice -----2
- Warning -----3
- 1. Product Introduction**
 - 1.1. The General Characteristics-----4
 - 1.2. The Advanced Technical Characteristics-----5
- 2. Introduction to the Front and Rear Panel**
 - 2.1. Front Display Panel Explanation-----6
 - 2.2. Rear Panel Explanation-----8
 - 2.2.1.General Explanation-----8
 - 2.3. Communication Port Explanation-----10
- 3. Installation and Operation**
 - 3.1. Unpacking-----11
 - 3.2. Selecting Installation Position-----11
 - 3.3. Operation Test and Installation Instruction-----12
 - 3.4. Storage Instruction-----13
 - 3.5. SNMP Slot-----13
- 4. UPS Working Principle**
 - 4.1. When Utility is Normal-----16
 - 4.2. When Utility is Abnormal-----16
 - 4.3. Overload Condition-----17
 - 4.4. Inverter Is out of Order-----18
 - 4.5. Inverter Over Temperature-----18
 - 4.6. Inverter Over-current and Inverter Output Voltage Out of Window-----18
- 5. Troubleshooting & Maintenance Guide**
 - 5.1. System Block Diagram-----19
 - 5.2. Troubleshooting-----19
 - 5.3. Maintenance-----20
- 6. Bundled Software Installation Guide**
 - 6.1. Hardware Installation-----21
 - 6.2. Software Installation-----21
- Appendix**
 - A.1.Specification-----24

IMPORTANT SAFETY INSTRUCTIONS

SAVE THESE INSTRUCTIONS

This manual contains important instructions that should be followed during installation and maintenance of the UPS and batteries.

An Important Notice

- To ensure safety in all applications where a UPS is hard wired to the electrical supply, ensure that the system is installed by a qualified electrical contractor.
- Those UPS systems supplied with a factory input lead can be safely connected to the wall socket by the purchaser.
- The UPS has its own internal energy source (battery). Should the battery be switched on when no AC power is available, there could be voltage at the output terminals.
- Make sure that the AC Utility outlet is correctly grounded.
- Do not open the case as there are no serviceable parts inside. Your warranty will be void.
- Do not try to repair the unit yourself, contact your local supplier or your warranty will be void.
- Please make sure that the input voltage of the UPS matches the supply voltage.
- Use a certified input power cable with the correct plugs and sockets for the appropriate voltage system.
- To eliminate any overheating of the UPS, keep all ventilation openings free from obstruction, and do not store "things" on top of the UPS. Keep the UPS 20 cm away from the wall.
- Make sure the UPS is installed within the proper environment as specified. (0-40°C and 30-90% non-condensing humidity)
- Do not install the UPS in direct sunlight. Your warranty may be void if the batteries fail.
- Install the UPS indoors as it is not designed for installation outdoors.
- Dusty, corrosive and salty environments can do damage to any UPS.
- Install the UPS away from objects which give off excessive heat and areas which are excessively wet.
- If liquids are split onto the UPS or foreign objects dropped into the unit, the warranty will be null and void.
- The battery will discharge naturally if the system is unused for any length of time.
- It should be recharged every 2-3 months if unused. If this is not done, then the warranty will be null and void. When installed and being used, the batteries will be automatically recharged and kept in top condition.

- This UPS supports electronic equipment in offices, telecommunications, and process control, medical and security applications.
- This UPS has been designed and constructed to protect your assets from the wide range of power aberrations experienced on Utility power lines today. It is your insurance for reliable, clean and stable voltage supply. It is worth taking care to install the system correctly and to have it maintained correctly by your local distributor.
- **WARNING:**
This is a Class A-UPS product. In a domestic environment, This product may cause radio interference, in which case, The user may be required to take additional measures.
- Intended for installation in a controlled environment.
- Servicing of batteries should be performed or supervised by personnel knowledgeable of batteries and the required precautions. Keep unauthorized personnel away from batteries.
- When replacing batteries, replace with the same number and type.
- **CAUTION** – Do not dispose of battery or batteries in a fire. The battery may explode.
- **CAUTION** – Do not open or mutilate the battery or batteries. Released electrolyte is harmful to the skin and eyes. It may be toxic.
- **CAUTION** – Risk of electric shock – battery circuit is not isolated from ac, hazardous voltage may exist between battery terminals and ground. Test before touching.
- **CAUTION** – A Battery can present a risk of electrical shock and high short circuit current. The following precaution should be observed when working on batteries:
 - a. Remove watches, rings, or other metal objects.
 - b. Use tools with insulated handles.
 - c. Wear rubber gloves and boots.
 - d. Do not lay tools or metal parts on top of batteries.
 - e. Disconnect charging source prior to connecting or disconnecting battery terminals.
- **CAUTION** – To reduce the risk of fire, connect only to a circuit provided with 20 amperes maximum branch circuit over current protection in accordance with the National Electric Code, ANSI/NFPA 70.(1K/2K)
- **CAUTION** – To reduce the risk of fire, connect only to a circuit provided with 30 amperes maximum branch circuit over current protection in accordance with the National Electric Code, ANSI/NFPA 70. (3K)

Chapter One: Product Introduction

1.1. The General Characteristics

- True online architecture continuously supplies in your critical device with a stable, regulated, transient-free pure sine-wave AC Power.
- 50 KHz PWM sine-wave topology yields an excellent overall performance.
- The high crest factor of the inverter handles all high-inrush current loads without a need to upgrade the power rating.
- To protect the unit from overloading, it automatically switches to bypass mode in case loading exceeds 120% of rating. It will automatically switch back to inverter mode once overload condition ceases.
- Should the output becomes short-circuited, the UPS holds the system and cuts the output automatically till the short circuit situation is removed.
- Should the unit become overheated, the internal thermistor will detect the heat and switch to bypass mode and vice versa.
- Maintenance-free sealed-type battery minimizes after-sales service.

1.2. The Advanced Technical Characteristics

- Market leading light and compact design for modern OA environment and OEM flexibility.
- Powerful CPU integrates all power stages, control and communication functions necessary for maximized UPS protection and functionality, including power management status monitoring, configuration setting operation scheduling, remote control and self-diagnosis.
- Slick CPU communication design allows full function remote control from any computer environment via standard RS-232 interface using Megatec's RUPSII protocol.
- State-of-the-Art IGBT Technology and Industrial Grade quality ensures highest efficiency and reliability under worst operating condition.
- Industry leading inverter protection technology incorporates 2-stage output current sensor, smart overload output current control, improved crest factor, and feedback failure proof circuit, elevating the availability of power service.
- Guarantees an exclusive protection against DC damage for inductive load, such as motor based devices, entirely eliminating application limitation.
- Advanced Input PFC control guarantees the PF performance and maximum energy efficiency.
- Unique electronic over-current protection detects output short-circuit and faults, and halts output before damages done to output fuse or equipment, thereby minimizing the need for service.
- Expanded input voltage working range minimizes battery usage and enhances battery utilization and life.
- Automatic Frequency Sensor reduces headache in frequency shift.
- DC-start function makes sure of the start-up of UPS during power outages.
- On-demand self-diagnosis function ensures UPS reliability and availability.
- Built-in supplementary charger enables speediest charging of external battery bank.
- SNMP adapter slot represents the advanced upgrade solution to achieve direct power management via the internet world-wide.
- User's adjustable Output DIP switches allow you to select an accommodate output voltage for your critical device.

Chapter Two: Introduction to the Front and Rear Panel

2.1. Front Display Panel Explanation

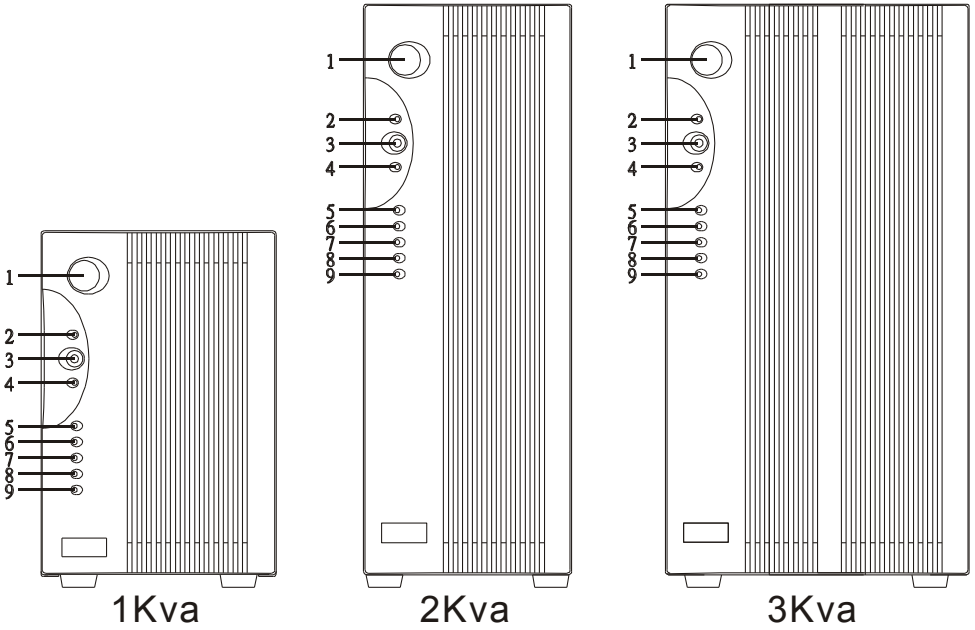

1.	Main Switch	This is control the on/off of the UPS
2.	Self Test OK LED	Green LED lights up if self test is O.K.
3.	Test/Silence	<p>a. To silence alarm by pressing the button.</p> <p>b.1.For Standard Unit To execute the self test of the UPS by pressing the button over 10 sec.</p> <p>b.2.For Unit with Manual Bypass function (Special order required) To press the button over 5 seconds, the UPS will be switched to Bypass mode and vice versa.</p> <p>c. To illustrate the percentage of output load level at AC Mode, and the battery energy level at Backup Mode by pressing the button.</p>
4.	Fault LED	Red LED lights up if UPS is faulty.
5.	Bypass LED	Amber LED lights up when UPS is in Bypass mode.
6.	Utility LED	<p>a. AC normal: Green LED lights up.</p> <p>b. 100% for load & battery level</p>
7.	Inverter LED	<p>a. Inverter On: Green LED lights up</p> <p>b. 75% for load & battery level.</p>
8.	Battery low LED	<p>a. Battery low : Red LED lights up</p> <p>b. 50% for load & battery level</p>
9.	Over load LED	<p>a. Over load condition: Red LED lights up</p> <p>b. 25% for load & battery level.</p>

2.2. Rear Panel Explanation

2.2.1 General Explanation

a) 120Vac

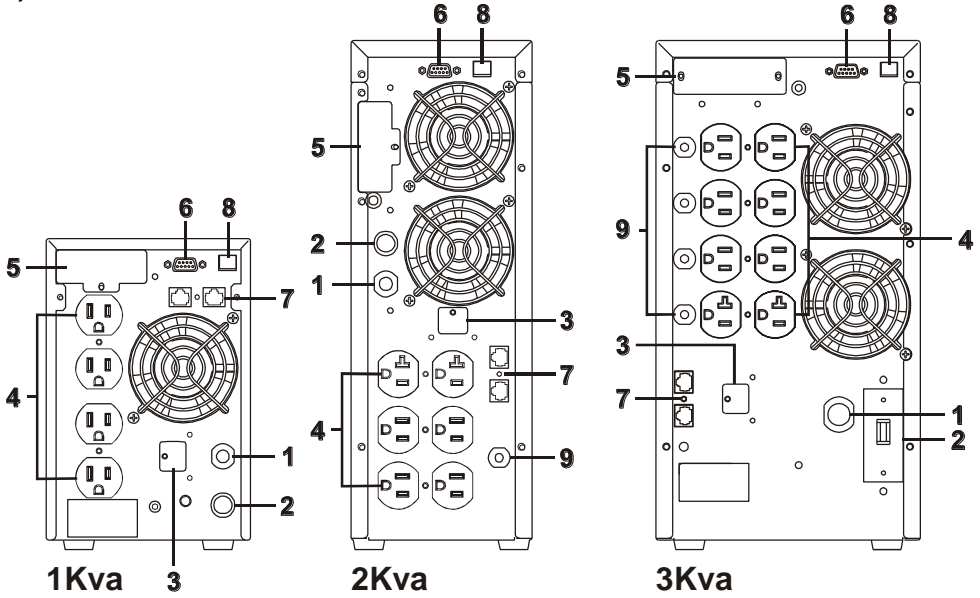

b) 230Vac

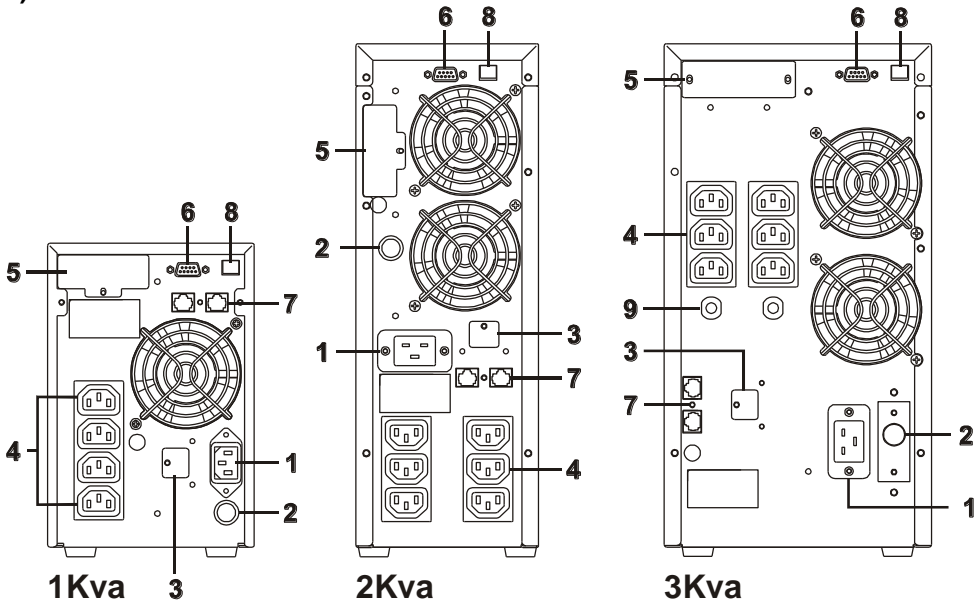

1)	AC Inlet	This is to be connected with an AC power cord for plugging into the wall receptacle.			
	For 120Vac System	1Kva	2Kva	3Kva	
		5-15P	5-20P	L5-30P	
	For 230Vac System	1Kva	2Kva	3Kva	
IEC 320		IEC 320	IEC 320		
2)	AC Input Fuse/ Breaker	This is to disconnect line input to protect application from Output overload or short circuit.			
	Fuse/Breaker Rating for 120Vac/230Vac systems				
	1Kva	2Kva	3Kva		
	120Vac: 20A/250V 230Vac: 10A/250V	120Vac: 25A/250V 230Vac: 20A/250V	120Vac: 50A/250V 230Vac: 25A/250V		
3)	External Battery Terminal	This is a battery terminal to be connected with additional battery banks for longer backup time purpose. Only a qualified technician is permitted to proceed with the installation.			
4)	AC Outlet	This is to be plugged by the devices being protected by the UPS.			
	For 120Vac System	Socket type	1Kva	2Kva	3Kva
		NEMA 5-15R	4ea	4ea	6ea
		NEMA 5-20R	N/A	2ea	2ea
	For 230Vac System	Socket Type	1Kva	2Kva	3Kva
IEC 320		4ea	6ea	6ea	
5)	SNMP Slot	It is an optional feature used for SNMP card. Please Refer to Chapter 3.5 for hardware installation.			
6)	Comm Port	This is an interface to send signals to and receive signals from the computer. An optional computer software may be required. Please refer to Chapter 2.3 for its pin assignments.			
7)	RJ11/RJ45 Jack	Noise suppression is provided for modem (RJ11) or 10-Base T Network (RJ45) devices			
8)	DIP Switches	For Calibration.			
9)	AC Output Breaker	Rating	1Kva	2Kva	3Kva
	120Vac	N/A	15A-NEMA5-15R	15A-NEMA5-15R 20A-NEMA5-20R	
	230Vac	N/A	N/A	10A	

2.3. Communication Port Explanation

The communication port on the rear panel of the UPS is a true RS232 serial type. It may be connected to a computer and allows the computer to monitor the status of UPS, and controls the operation of the UPS, via an additional UPS software kit. The bundled software of the UPS is for Windows. Full function remote control from any computer is via standard RS232 interface using MegaTec's RUPS II protocol.

2.3.1. The RS232 interface settings

The RS232 interface shall be set as follows:

Baud Rate	2400 bps
Data Length	8 bits
Stop Bit	1 bit
Parity	None

2.3.2. The Pin Assignments of true RS232 type

The Pin Assignments of true RS232 type are illustrated as follows:

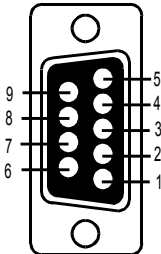

Pin 6: RS232 Rx

Pin 9: RS232 Tx

Pin 7: Ground

Chapter Three: Installation and Operation

The packing condition and the external outlook of the unit should be inspected carefully before installation. Retain the packing material for future use.

3.1. Unpacking

1. Take the UPS out of the PE foam.
2. Unwrap the UPS.
 - a. The UPS itself is approx. 12.5~39kgs, so be careful when unpacking and lifting the unit. Improper use of force might harm you.
 - b. The plastic bag holding the UPS is very slippery, so be careful in Unpacking and holding the unit. The unit might drop accidentally and cause harm to yourself.
3. Standard Package includes:
 - User's Manual
 - AC Input Power Cord (Not available for hard wiring connection models)
 - IEC output cables (for the UPS with IEC sockets only)
 - RJ11 Phone Jack Cable
 - UPS communication kit (optional)

3.2. Selecting Installation Position

It is necessary to select a proper environment to install the unit, in order to minimize the possibility of damage to the UPS and extend the life of the UPS. Please follow the advice below:

1. Keep at least 20cm (8 inches) clearance from the rear panel of the UPS to the wall.
2. Do not block the airflow to the ventilation openings of the unit.
3. Please check the installation site to avoid overheat and excessive moisture.

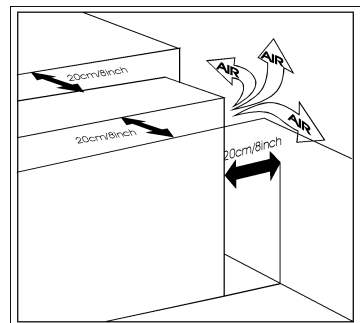

4. Do not place the UPS in an environment near dusty, corrosive or salty material or flammable objects.
5. Do not expose the UPS to outdoors.

3.3. Operation Test and Installation Instruction

The installation should be conducted or supervised by a qualified technician to avoid accident. Charge the UPS for more than 8 hours after unpacking to ensure the UPS is fully charged before usage.

1. Make sure the grounding of wall receptacle is properly done.
2. Verify if the voltage and frequency ratings match that of Utility, then connect the AC Input power cord to a verified grounded 3-wire receptacle.
3. Turn on the Main switch on the front panel to start the UPS, then the fan on the rear panel will spin.
4. After 7~10 seconds, the start-up Of UPS will be completed, then the "Utility" LED and Inverter" LED will light up simultaneously.
7. Disconnect the input power cord of the UPS to see whether the UPS remains operation when Utility is abnormal.

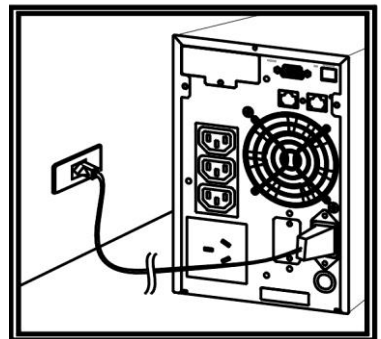
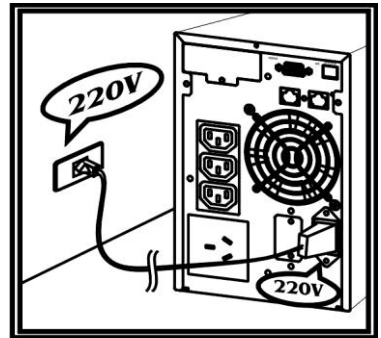
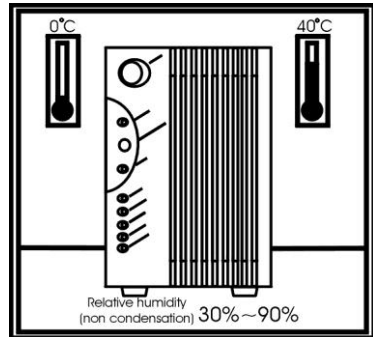

6. Re-connect the input power cord of the UPS to wall receptacle, then connect the power cord of your device to the output receptacle of the UPS.
7. Turn on the Main switch on the front panel. The "Utility" LED and "Inverter" LED will light up in 7~10 seconds, then turn on the switch of the device connected. Do not execute any critical application yet!
8. Disconnect the UPS from the wall receptacle to simulate Utility failure. The "Utility" LED should extinguish and the alarm will sound continuously till battery cutoff. The device connected to the UPS shall operate continuously. To mute the audible alarm, please push the Test/Silence Button on the front panel.
9. Your installation is done successfully.

3.4. Storage Instruction

For extended storage through moderate climate, the batteries should be charged for 12 hours every 3 months by plugging the UPS power cord into the wall receptacle. Repeat this every 2 months under high temperature environment.

3.5. SNMP Slot

You may install the SNMP card into the SNMP slot on the rear panel of the UPS. The UPS may be connected to the network management system via the SNMP card. The SNMP slot kit is an optional feature of the UPS, so you shall purchase the kit from your local distributor before installing the SNMP card.

The installation shall be executed by a qualified technician authorized by your local distributor.

1.The UPS shall be located in a proper location as described in Chapter 3.2.

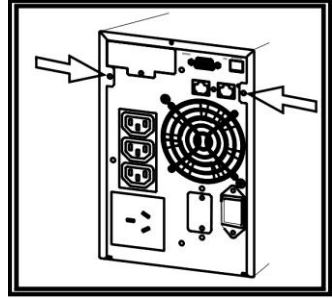

2.Remove the top cover of the UPS. Install the SNMP slot kit onto the rear panel of the UPS.

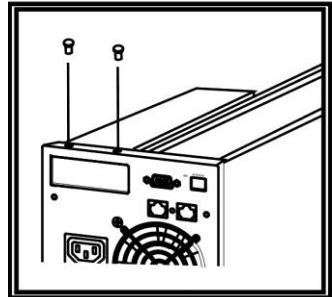
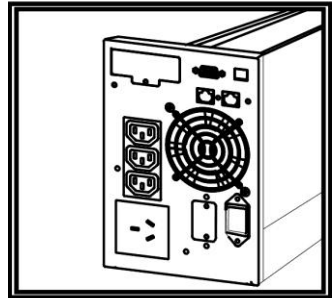

3.Insert the SNMP card into the SNMP slot as guided.

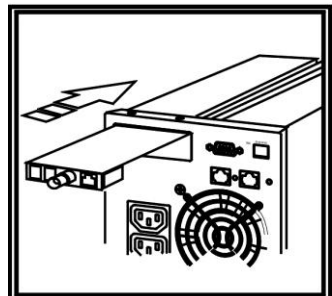

4. Connect the harness from the kit to the connector on the Control Logic board.

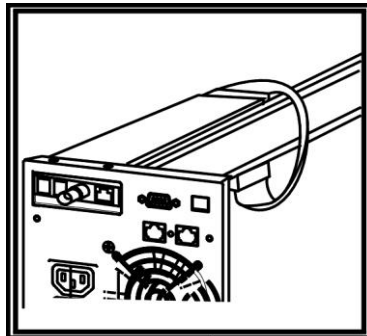

5. Fasten the SNMP card properly and put the top cover of the UPS back to its position.

6. Connect the network cable from the network device (ex. Hub) with SNMP accessibility to the UPS and set the SNMP card to "configuration" mode and configure the SNMP card. (Please refer to the user's manual of the SNMP Card for configuration instruction.) Your hardware installation is now completed.

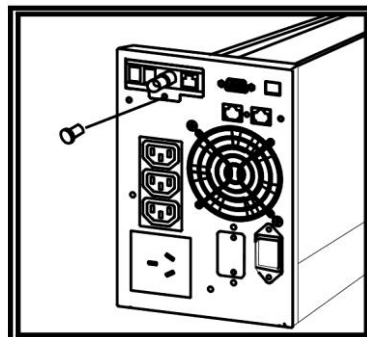

Chapter Four: UPS Working Principle

4.1. When Utility is Normal

The working principle of the UPS under Utility normal condition is illustrated as follows,

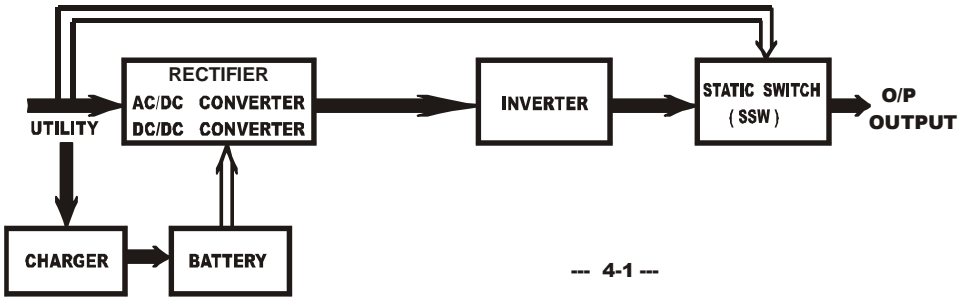

When Utility is normal, the AC source is rectified to DC, partially fed into the charger to charge battery and partially fed into inverter. The inverter reverts the DC to AC to supply energy to the load connected. The Utility LED and Inverter LED Light up.

4.2. When Utility is Abnormal

The working principle of the UPS under Utility abnormal condition is illustrated as follows,

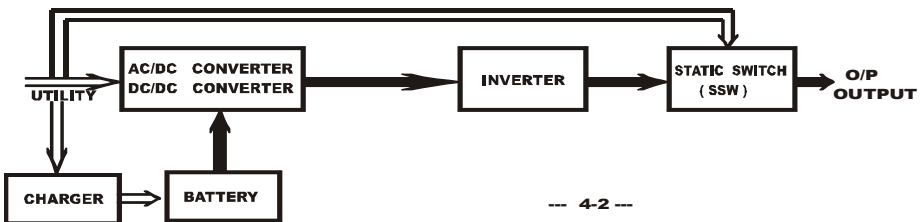

When Utility is abnormal, the UPS will direct the battery energy automatically to the Inverter, and turn off the charger and AC/DC converter. The inverter reverts DC to AC to supply energy to the output load connected. The Inverter LED lights up.

When Utility is back to Normal, the UPS will turn on the AC/DC converter, turn off DC/DC converter and turn back charger to charging position. It has the same working principle as figure 4.1.

During a blackout, the UPS will work as illustrated in figure 4.2. When Battery is low, buzzer will beep continuously till battery is completely cut off. The battery low protection of the UPS will cut off battery supply before battery drains to avoid from battery over-drain. The Inverter LED and Bat. Low LED will light up till the UPS is completely cut off. The UPS will re-start automatically when Utility is back to Normal. The working principle is the same as figure 4.1.

4.3. Overload Condition

The working principle of the UPS when overloading is illustrated as follows,

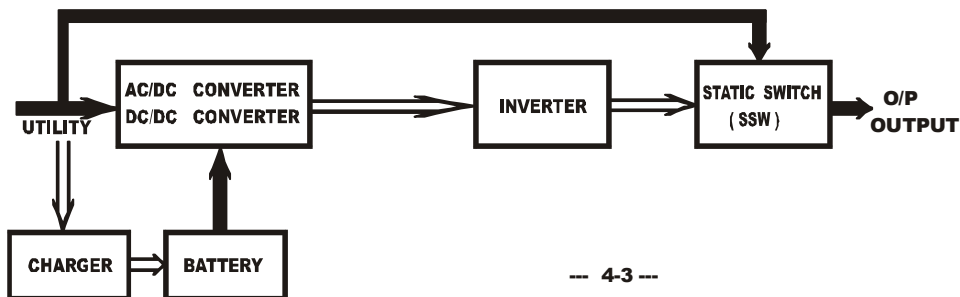

Normally, an inrush current is generated when switching on the connected device. If the UPS is in 105~120% loading, it will switch to bypass mode in 60 seconds. If The UPS is in 120%-150% loading, it will switch to bypass mode in 10 seconds. If The UPS is over 150% loading, it will switch to bypass mode immediately. The Utility LED, Bypass LED and Over Load LED light up. If overload condition is eliminated by reducing the load to 80%~90%, the UPS will switch back to Inverter mode automatically.

4.4. Inverter is out of Order

4.4.1. Output short circuit under inverter mode

If output load is short circuited under inverter mode, the UPS will turn off the output to prevent load from damage. The Fault LED lights up and the buzzer sounds continuously. The UPS cannot turn on automatically after short circuit condition is eliminated. You are required to re-start the UPS manually. To re-start the UPS after short circuit condition is removed, you shall push the Main Switch on the front panel to "OFF" position first, then to "ON" position again.

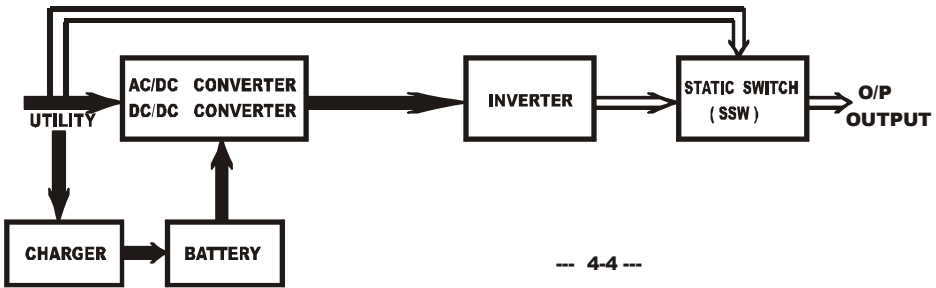

4.4.2. Output Short circuit under bypass Mode

If output load is short circuited under bypass mode, the AC fuse will trip open to prevent the output load from damage. You shall replace a new fuse with same rating after the short circuit condition is eliminated.

4.5. Inverter Over temperature

If the UPS experiences over-temperature when Utility is normal, it will switch to bypass loop. The UPS will switch back to inverter mode when the over-temperature situation is eliminated. If it happens when Utility is abnormal, the buzzer will beep continuously and the Fault LED will light up. The output of the UPS will also be cut off.

4.6. Inverter Over-current and Inverter Output Voltage Out of Window

If the UPS inverter delivers over-current and out-of-window voltage to output, the UPS is out of order. The UPS will switch to bypass loop when Utility is normal. The Utility LED, Bypass LED and Fault LED will light up. If these two conditions occur when Utility is abnormal, the UPS will turn off the Output and the Fault LED will light up.

Chapter Five: Maintenance Guide

5.1. System Block

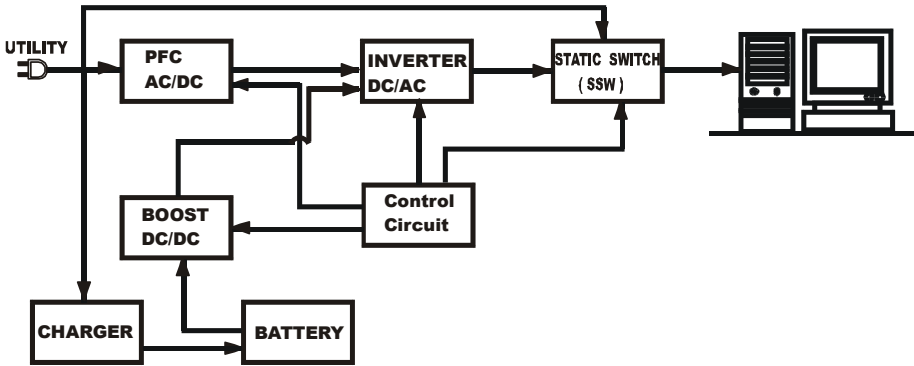

5.2 Trouble Shooting

When the UPS malfunctions during operation, you may check the list below for proper adjustment. Should the problem persists, please Contact your local distributor for help.

Situation	Check Items	Solution
Utility LED is not on and the UPS is on battery mode, when Utility is normal.	AC Input cord is loose or AC Input fuse is broken.	1.Connect the AC Input cord to wall receptacle. 2.Replace the AC fuse with same rating one. 3.If problem persists, please call for service.
The UPS switches to battery mode then back to Utility mode, when connected device is turned on. Or, the UPS Switches back and forth between battery and Utility.	1.Check if any power strip is connected to the UPS. 2.Any damage of Wall Receptacle.	1. Do not use power strip. 2. Replace the wall receptacle.
Overload LED lights up		UPS is overloaded. Please remove some load at the output end of the UPS till the RED LED extinguishes.

Situation	Check Items	Solution
Battery Low LED lights up		Battery is running out. Please proceed to shutdown your load & application Immediately then recharge the battery.
Fault LED lights up		Disconnect the output load immediately and re-switch on the UPS to see if the "Fault" LED Is still on. If not, your output load has probably been shorted. Otherwise, call for service.
System fails to backup when Utility fails.		Disconnect the input power cord from the rear panel and re-turn on the front Switch to see if the UPS is on again. If not, call for service.
UPS is normal but no Output to load	Check to see if all cords are properly connected as desired.	Check all outlets to see if they are properly connected.
Strange noise and smell		Immediately shut down the whole System. Disconnect the power from the UPS and call for service.

5.3. Maintenance

Clean the dust from the ventilation openings and intakes on the rear panel.

- Turn off the UPS and wipe the casing with a damp cloth.
- Periodically unplug the power cord of the UPS from the wall receptacle to test the batteries condition.
- Be sure you have already saved your application before you proceed with the battery discharging capability test.

Chapter 6: Bundled Software Installation *Guide*

6.1. Hardware Installation

1. Connect the male connector of RUPS II cable to the UPS communication port.
2. Connect the female connector of RUPS II cable to a dedicated RS232 port. If there is only a DB25 connector of the RS232 port available, you may use a DB9-DB25 adapter to convert it.

6.2. Software Installation

6.2.1. RUPS II Installation

A. *RUPS II for MS-DOS*

1. Insert the system diskette into your floppy disk driver and execute **INSTALL.EXE** under MS-DOS.
A:\>CD\DOS<Enter>
A:\DOS>INSTALL<Enter>
2. Please select the MS-DOS menu from the installation menu box, And give the path of RUPS II system diskette and the designated directory of it. (You may use the default value of RUPS II)
3. The installation program will copy all required files of the RUPS II into the designated path. It will also append a *Load RUPS.EXE Command* in your **AUTOEXEC.BAT** file automatically. After a complete installation is done, the installation program will execute the **CONFIG.EXE** automatically. You may modify the configurations of RUPS II now.

B. *RUPS II for Windows 3.1, Windows 95, 98, Windows NT*

1. Execute "**A:\Windows\setup.exe**" under Windows system. (This procedure can be achieved either by file manager or from the "RUN" command of Windows.)
2. The RUPS II Setup group is labeled as RUPS2W, you may Re-setup it to the desired group you wish.

C. RUPS II for Novell Netware(Optional)

1. Login the File Server as a **SUPERVISOR** or a **USER with Access Right in sub-directory SYS:SYSTEM.**

F:\>LOGIN SUPERVISOR

2. Insert the system diskette into the floppy disk Driver A.
3. Execute **INSTALL.EXE** in Driver A.

F:\>A:

A:\>INSTALL

4. After the installation is complete, please shutdown your NetWare Operating System and re-start it. The system will load the PowerMan.NLM and execute it.
5. When the RUPS II for NetWare Is loaded, the Filer Server will broadcast a successful loading message on the screen. You may switch to the RUPS II Menu by pressing **ALT_ESC** simultaneously.

6.2.2. UPSilon 2000 Installation

A. UPSilon 2000 for Windows 95, 98, NT

1. From the Start Button, choose "Run".
2. Type D:\Windows\Setup.exe
3. Choose OK.

B. UPSilon 2000 for Novell Netware V3.1x

1. Login the File Server (with access rights in SYS: SYSTEM)
2. Execute D:\Netware\V3.1x\Install.exe
3. Re-boot System.

C. UPSilon 2000 for Novell Netware V4.x

1. Login the File Server (with access rights in SYS: SYSTEM)
2. Execute D:\Netware\V4.x\Install.exe
3. Re-boot System

D. UPSilon 2000 for Novell Netware V5.x

1. Login the File Server (with access rights in SYS: SYSTEM)
2. Execute D:\Netware\V5.x\Install.exe
3. Re-boot System

E. UPSilon 2000 for FreeBSD and *Linux*

1. Log in as a super-user.
2. Use the 'ftp' utility in MS-DOS to copy files into the system directory '/tmp'.
3. Follow the instructions below to make the filename conversion after the 'ftp'

File transfer:

```
#cd/tmp
```

```
#mv linux.z linux.Z, or
```

```
#mv LINUX.Z linux.Z
```

```
#chmod 755 install
```

4. Execute the installation program:
#./install
5. Select a target system from the menu, and configure the UPSilon for UNIX (Make sure no other process using the same serial port), the installation program will launch the UPSilon for UNIX daemon process automatically.

Appendix

A.1. Specifications

MODEL	1Kva	2Kva	3Kva
INPUT			
Voltage (Vac)	80~140 or 160~280		
Frequency (Hz)	50 or 60Hz, ± 5 Hz(Auto Sensing)		
Phase	Single		
Input Power Factor	> 0.98(Full Load)		
Surge Rating			
For 120Vac System	50 Joules	90 Joules	50 Joules
For 230Vac System	125 Joules	125 Joules	125 Joules
OUTPUT			
Voltage (Vac)	110/115/120 or 220/230/240 Factory Setting		
Capacity(VA/W)	1000/700	2000/1400	3000/2100
Wave Form	Sine Wave, THD<3%(no load to full load)		
Voltage Regulation	$\pm 2\%$		
Frequency (Hz)	50 or 60Hz, Synchronized to input line frequency, ± 0.5 Hz (Free Running)		
Transient Response (ms)	+/-4% Under full load change and corrected within 60ms		
Synchronization	1 Hz/Sec. Slew Rate: Inverter Free Running If Input Frequency exceeds ± 3 Hz Range		
Crest Factor	3 : 1		
Transfer Time (Line Fault)	0 ms		
Efficiency(AC to AC)	Up to 88%		
Run Time(Full Load)	7 Min.	7 Min.	7 Min.
DC Start	Yes		
BATTERY			
Type	Sealed Maintenance Free Lead Acid		
Quantity (pcs)	3	6	8
Voltage (Vdc)	36	72	96
Recharge Time	8 Hours To 90%		
Supplementary Charger(Optional)	200/500 watt charger for external battery application. Charger can be mounted in place of the internal battery or into an external BP.		
DISPLAY			
LED	Utility, Battery Low, Inverter, Bypass, Self- Test OK, Overload, Fault Conditions <i>Press the Self-Test Switch to display Load/Battery Level performing by above 7 LEDs. Load Level will be displayed on Line Mode, and it is Battery Level on Battery Mode.</i>		

MODEL		1Kva	2Kva	3Kva
PROTECTION				
	Overload	100% ~ 105% Continuously; 105% ~ 120% delay 50 seconds before switching to bypass; 120% ~ 150% delay 10 seconds before switching to bypass; > 150% immediately switch to bypass.		
	Short Circuit	a) Inverter Mode: UPS shutdown, Output shuts off b) Bypass Mode: AC Input fuse/breaker blows		
	Overheat	a) Utility Normal: Switch to Bypass. b) Utility Abnormal: Buzzer sounds continuously, Fault LED lights up then cut the output.		
	High Voltage Trip-Off	Switch to Backup Mode		
	Battery Low	Alarm continuously till battery cutoff		
	Noise Suppression	Comply with EN50091-2.		
	Spike Suppression	Comply with EN61000-4-5.		
ALARM				
	Audible and Visual	Line Failure, Battery Low, Transfer to Bypass, Overload, System Fault Conditions		
PHYSICAL				
	Dimensions (WxHxD, mm)	147x223x401	130x365x479	190x365x453
	Net Weight (Kgs)	15	27	36
	Outlets(IEC/Local)	Re detailed information, please refer to Chapter 2.2.		
ENVIRONMENT				
	Temperature	0°C~40°C		
	Humidity	90% RH Maximum, Non-Condensing		
	Noise	<45 dB (at 1 meter)		
COMPUTER INTERFACE				
	Interface Type	Standard RS232 Interface		
	Protocol	MegaTec RUPS II		
	SNMP Adaptability	Slot for standard SNMP Card kit. The standard kit will contain all required parts for installation in either tower or rack mount units.		
	Operating Systems Compatibility	Novell Netware, Windows95/98/NT/ME/2000/XP, Linux, and Free BSD		
SAFETY CONFORMANCE				
	Safety Standard	UL1778		
	EMI Standard	FCC Class A		
	Marks	UL,CE		

Above specifications are subject to change without prior notice. Trademarks of MegaTec, RUPS, IBM, MS-DOS, Novell Netware, Windows, OS/2, NetLite, HP-UX, AIX, SUN, UNIX, and XENIX and Linux are registered trademarks of their respective companies.