



# Series 405

1/16 DIN

## Timer with Instantaneous Relay

TIMERS



### PRODUCT HIGHLIGHTS

- On delay version with instantaneous relay
- Selectable On Delay/Interval Timing Mode version
- Output Contacts rated 10A 120/240 VAC and 30 VDC
- Six Timing Ranges in a single unit
- Timing Ranges:
  - 1 and 10 sec., min., and hours
  - 5 and 50 sec., min., and hours
- Universal Power Supply: 24-240 VAC and 24 VDC
- 48mm<sup>2</sup> DIN Standard housing
- Large and easy to read dial shows decimal points
- Round (octal) socket mount or mount in panel cutout
- Watertight when panel mounted
- Range and Mode select are tamper proof when panel mounted
- Unique flashing cycle progress indication

#### INSTANTANEOUS AND DELAYED RELAY VERSION

A version of the 405 is available with one set of SPDT instantaneous contacts and one set of SPDT delayed contacts. The instantaneous contacts transfer as soon as the timer is powered. The delayed contacts transfer at time out. This contact arrangement can be used to replace many conventional timers.

#### ON DELAY/INTERVAL TIMING MODE VERSION

A version of the 405 is available with selectable On delay or Interval timing modes. This version has a set of DPDT output contacts. When in the On delay mode, the contacts transfer at time out. When in the Interval mode, the contacts transfer when power is applied and release at time out.

#### UNIVERSAL POWER SUPPLY

All 405 timers can be powered using 24-240 VAC or 24 VDC power, greatly simplifying ordering and inventory management of replacement units.

#### HIGH ACCURACY

The 405's timing circuit is not a simple RC circuit. It utilizes the sophistication of a proprietary integrated circuit that includes counting technology along with a stable oscillator to provide repeatable time delays.

#### 48mm<sup>2</sup> DIN HOUSING

The 48mm<sup>2</sup> (1/16 DIN) housing is compact and is watertight when panel mounted. The 405 is mounted in an 8 pin round (octal) socket. With an optional mounting clip, the 405 can be panel mounted.

The Dial on the 405 is extra large and is easy to read. When fractional ranges are selected, decimal points are clearly indicated.

The Mode select and Range select switches are located on the side of the unit, so that when panel mounted, these switches are not accessible to the operator. This tamper proof feature prevents unauthorized or hazardous changes to the timing mode and range from being made.

#### CYCLE PROGRESS INDICATION

The 405 LED indicator provides a unique and effective method of cycle progress indication. Off before timing, the LED blinks at an ever increasing rate as the cycle progresses: once every 3 1/2 seconds during the first 10% of the cycle, twice during the second 10%, and so on. At time out, the LED pulses at a high rate. (In the 1, 5, 10 and 50 second ranges, the LED is Off before timing, steady On during timing, and pulsing On after time-out).

#### APPROVALS

See Agency Listing on inside back cover of catalog.

**OPERATION**

Timing begins when the start switch is closed. This starts an oscillator which runs at a frequency determined by the time setting. A fixed number of counts from the oscillator determines the end of the timing cycle. The time required to accomplish this depends upon the oscillator frequency. During timing, an LED located on the dial face blinks. For the first 10% of the cycle, LED repeatedly blinks once followed by a pause. For the second 10%, it blinks twice and so on indicating the cycle progress. The LED flashes rapidly and continuously after time out.

**MODEL...F1X**

The instantaneous contacts (3-1-4) transfer immediately after the start switch is closed. The delayed contacts (6-8-5) transfer after the timing cycle indicated on the front dial setting. Both contacts remain transferred until the unit is reset.

**MODEL...F2X**

**ON DELAY MODE** - At time out, the DPDT relay transfers its contacts. These contacts remain transferred until the start switch is opened or power is removed by some other means. The 405A then resets and is ready for another cycle.

**INTERVAL MODE** - When the start switch is closed, the DPDT relay transfers its contacts. The contacts remain transferred until time out. The timer will not start again until the start switch is opened or power is removed by some other means. The 405A then resets and is ready for another cycle.

**WIRING**

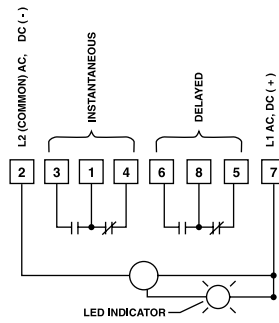

**Model 405A...F1X**

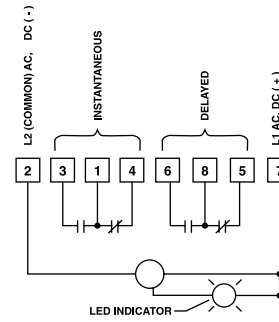

**Model 405A...F2X**

**TERMINAL WIRING**

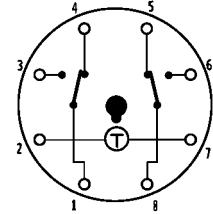

**Bottom View of TDR**

**TYPICAL CIRCUITS 405A...F1X**

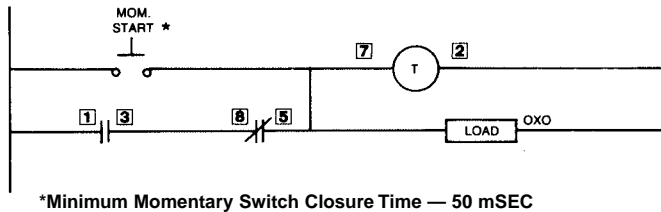

\*Minimum Momentary Switch Closure Time — 50 mSEC

**TYPICAL CIRCUITS 405A...F2X**

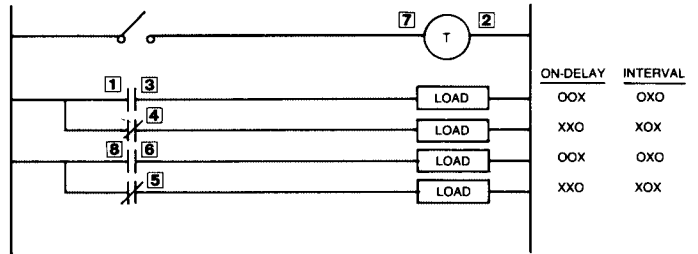

\* For Interval Operation With A Momentary Start Switch, Jumper 7 & 3

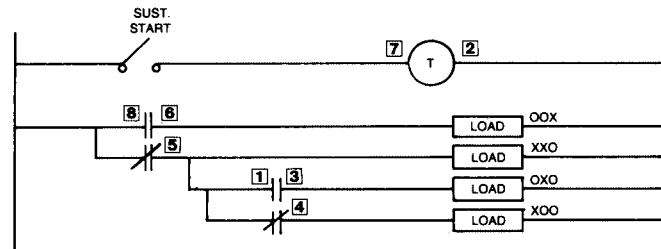

For Repeat Cycle Pulse Operation In On-Delay Mode.

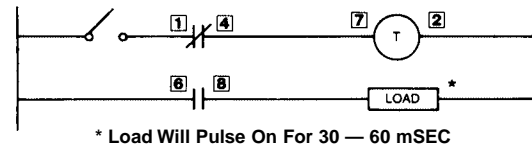

\* Load Will Pulse On For 30 — 60 mSEC

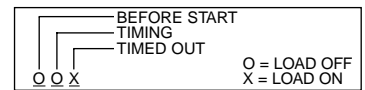
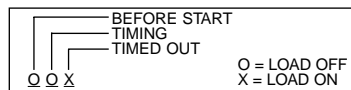

Before starting your design, read the safety statement on the inside back cover of the ATC catalog.

**SPECIFICATIONS**

**For Model 405A Timer/TDR**

**MODELS**

405A100F1X - On Delay w/instantaneous & delayed relays (1 or 10 SEC/MIN/HRS)

405A500F1X - On Delay w/instantaneous & delayed relays (5 or 50 SEC/MIN/HRS)

405A100F2X - On Delay/Interval with (1) DPDT relay (1 or 10 SEC/MIN/HRS)

405A500F2X - On Delay/Interval with (1) DPDT relay (5 or 50 SEC/MIN/HRS)

Both models available in 6 ranges from 1 sec. to 10 hrs. or 5 sec. to 50 hrs.

**CONTACT RATING**

Rated 10 AMPS resistive at 30 VDC or 250 VAC (or less)  
 1/8 HP @ 120 VAC  
 1/4 HP @ 240 VAC  
 240 VA @ 240 VAC

LIFE: 10 million operation with no load  
 100,000 operations with:  
 10 AMPS at 30 VDC (or less) or  
 10 AMPS at 250 VAC (or less)

CONTACT MATERIAL:  
 Silver Cadmium Oxide

**TEMPERATURE RATING**

-18°C to 60°C (0 to 140°F)

**NOISE IMMUNITY**

Showering ARC per NEMA ICS 2-230. In addition, the 405A will withstand a voltage surge of 4500 volts for 50 usec. without damage.

**MOUNTING**

Plug-in octal base; mounts in any position with retaining clip.

- Options: Surface mounting socket
- DIN rail mounting socket
- Panel-mounting adapter kit
- Plug-on socket kit

**POWER REQUIREMENTS**

Universal power supply - reverse polarity protected

Unit will accept power from 24 to 240 VAC, 50 or 60 Hz, (+10%, -20%)  
 24 VDC (+20%, -20%)

**AC:** Inrush - 1.5 Amps  
 Power required - 1.2 watts

**DC:** Maximum ripple @100Hz - 5%  
 Current required - 50mA  
 Power required - 1.2 watts  
 "F" option - Peak inrush current = 2 AMPS @ 24 VDC  
 "N" option - Peak inrush current = 150 mA @ 24 VDC

**REPEAT ACCURACY**

Varies as a function of temperature.  
 Any voltage (constant temperature): +/-0.5%\*  
 Any voltage (32° F to 140° F): +/-1.5%\*  
 Any voltage (0° F to 140° F): +/-2.0%\*

\*Variation from average actual time.

**MINIMUM SETTING**

2% of range, with the exception of 50 msec on the 1 second range

**SETTING ACCURACY**

+/-5% of range

**RESET**

- a. 0 to 20 msec power interruption: guaranteed no reset.
- b. 20 to 65 msec; it may reset (40 msec typical reset).
- c. Over 65 msec guaranteed to reset.

The TDR will reset properly and not start timing when subjected to an open start switch leakage of 1.5 mA or less. (Prox switch and Triac drive applications)

**WEIGHT**

5 oz. (140g)

**DIMENSIONS:**

**INCHES**  
**MILLIMETERS**

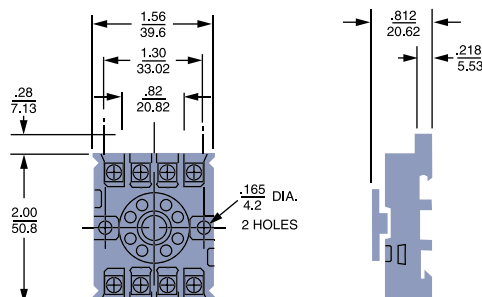
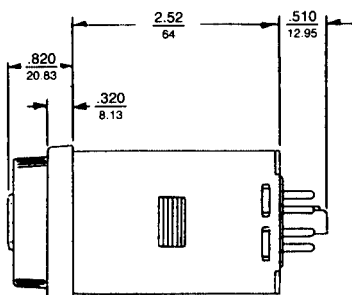
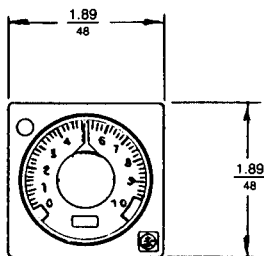

8 PIN OPTIONAL OCTAL SOCKET NO. 00008258500

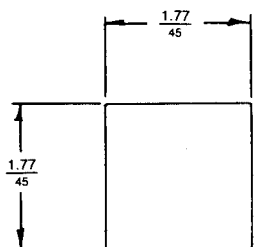

CUTOUT

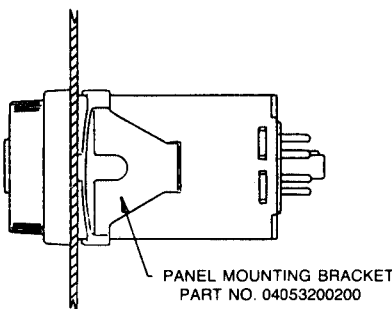

PANEL MOUNTING (UP TO .188 THICK)

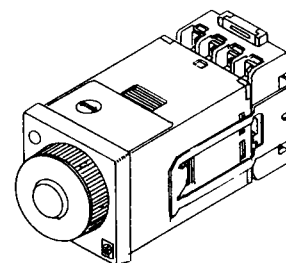

00008258500 SOCKET WITH 04070251300 HOLD DOWN

**SERIES 405A TIMER/TDR**

ORDERING CODE

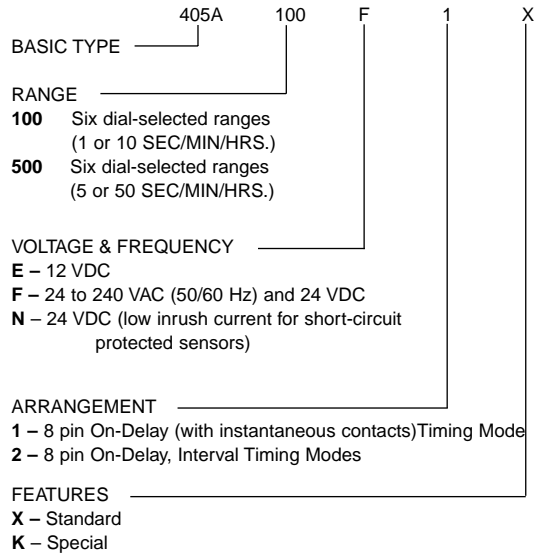

**ACCESSORIES**

- 0000-825-85-00** 8 Pin surface/DIN rail socket
- 0407-025-13-00** Hold down for above socket
- 0405-320-02-00** Panel mounting bracket
- 0319-261-45-00** Plug on socket kit (8-pin)
- 0000-825-87-00** 8 Pin panel socket w/rear facing terminals

Before starting your design, read the safety statement on the inside back cover of the ATC catalog.