

1/16-DIN PROCESS CONTROLLER CONCISE PRODUCT MANUAL (59300-2)



CAUTION: Installation and configuration should be performed only by personnel who are technically competent to do so. Local Regulations regarding electrical installation & safety must be observed.

1. INSTALLATION

Panel-Mounting

The mounting panel must be rigid and may be up to 6.0mm (0.25 inches) thick. The cut-out required for the instrument is shown on the right. Instruments may be mounted side-by-side in a multiple installation for which the cut-out width (for *n* instruments) is (48*n*-4)mm or (1.89*n*-0.16)inches.

45 x 45mm
+0.5 -0.0

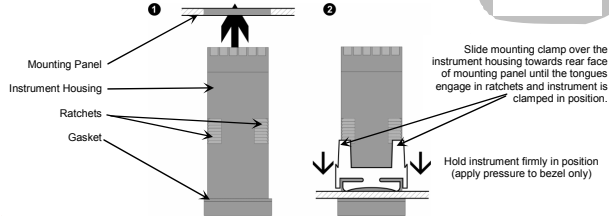

CAUTION: Do not remove the panel gasket; it is a seal against dust and moisture.

Rear Terminal Wiring

USE COPPER CONDUCTORS (EXCEPT FOR T/C INPUT)
Single Strand wire gauge:
Max 1.2mm (18SWG)

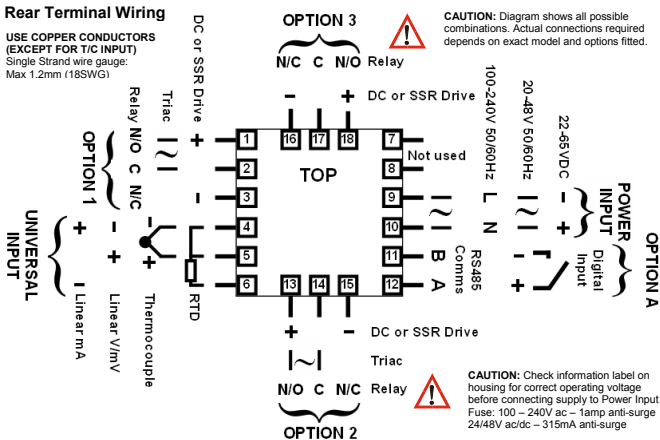

Installing Option Modules



CAUTION: Turn off all power. Remove instrument by gripping the sides of the front panel and pulling the instrument out of its housing. **Note its orientation.**

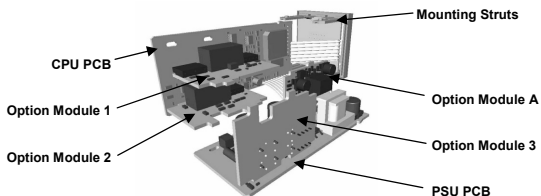

To access modules 1 or A, first detach the PSU and CPU boards from the front moulding by lifting first the upper, and then lower mounting struts. Gently separate the boards.

- Plug the required option modules into the correct connectors, as shown below.
- Locate the tongues on each module into the corresponding slot in the board opposite.
- Hold the main boards together while relocating them back on the mounting struts.
- Replace the instrument by aligning the CPU and PSU boards with their guides in the housing, then slowly push the instrument back into position.

Note: The instrument will automatically detect which option modules have been fitted.

Option Module Connectors

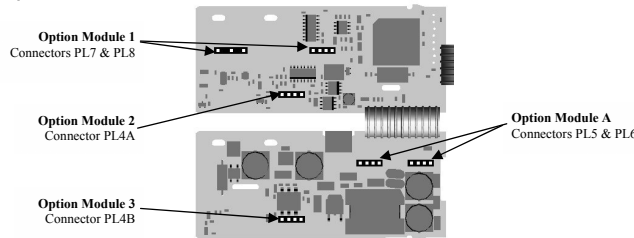

2. SELECT MODE

Select mode is used to access the configuration and operation menu functions. It can be accessed at any time by holding down **⏏** and pressing **⏏**. Once in select mode, press **⏏** or **⏏** to select the required mode. An unlock code is required to prevent unauthorised entry to Configuration, Setup & Automatic Tuning modes. Press **⏏** or **⏏** to enter the correct code number, then press **⏏** to proceed.

Mode	Upper Display	Lower Display	Description	Default	Unlock Codes
Operator	OPtr	SLCt	Normal instrument operation.		None
Set Up	SEtP	SLCt	Tailor settings to the application.		10
Configuration	ConF	SLCt	Configures the instrument for use.		20
Product Info	rFo	SLCt	Check manufacturing information.		None
Auto-Tuning	Autun	SLCt	Invoke Pre-Tune or Self-Tune.		0

Note: The instrument will always return automatically to Operator mode if there is no key activity for 2 minutes.

3. CONFIGURATION MODE

First select Configuration mode from Select mode (refer to section 2). Press **⏏** to scroll through the parameters, then press **⏏** or **⏏** to set the required value. To accept a change **⏏** must be pressed, otherwise parameter will revert to previous value. To exit from Configuration mode, hold down **⏏** and press **⏏**, to return to Select mode. **Note: Parameters displayed depends on how instrument has been configured. Parameters marked * are repeated in Setup Mode.**

Parameter	Lower Display	Upper Display	Adjustment range	Default
Input Range/Type	rPt		See following table for possible codes	J T/C
Scale Range Upper Limit	rUL		Scale Range Lower Limit +100 to Range Max	Range max (Lin=1000)
Scale Range Lower Limit	rLL		Range Min. to Scale Range Upper Limit -100	Range min (Linear=0)
Decimal point position	dPo5		0=XXXX, 1=XXX.X, 2=XX.XX, 3=X.XXX (non-temperature ranges only)	1
Control Type	CtYP	SrGL	Primary (heat) only	SrGL
Primary Output Control Action	CtL	rEu	Reverse Acting	rEu
	dIr		Direct Acting	
Alarm 1 Type	ALA1	P_H	Process High Alarm	P_H
		P_Lo	Process Low Alarm	
		dE	Deviation Alarm	
		bAnd	Band Alarm	
		nonE	No alarm	
High Alm 1 value*	PhR1		Range Min. to Range Max in display units	Range Max.
Low Alm 1 value*	PLR1			Range Min.
Band Alm 1 value*	bAL1		1 LSD to span from setpoint in display units	5
Dev. Alm 1 value*	dAL1		+/- Span from setpoint in display units	5
Alm 1 Hysteresis*	AHY1		1 LSD to full span in display units	1
Alarm 2 Type*	ALAR2			P_Lo
High Alm 2 value*	PhR2			Range Max.
Low Alm 2 value*	PLR2			Range Min.
Band Alm 2 value*	bAL2		Options as for alarm 1	5
Dev. Alm 2 Value*	dAL2			5
Alm 2 Hysteresis*	AHY2			1
Loop Alarm	LAE		d SA (disabled) or EnAb (enabled)	d SA
Loop Alarm Time*	LAt		1 sec to 99 mins. 59secs (only applies if primary proportional band = 0)	99.59





Parameter	Lower Display	Upper Display	Adjustment range	Default
Alarm Inhibit	Inh	nonE	No alarms Inhibited	nonE
		ALA1	Alarm 1 inhibited	
		ALA2	Alarm 2 inhibited	
Output 1 Usage	USE1	Pr	Primary (Heat) Power	Pr
		SEc	Secondary (Cool) Power	
		AL_d	Alarm 1, Direct	
		AL_r	Alarm 1, Reverse	
		AL_d	Alarm 2, Direct	
		AL_r	Alarm 2, Reverse	
		LP_d	Loop Alarm, Direct	
		LP_r	Loop Alarm, Reverse	
		OR_d	Logical Alarm 1 OR 2, Direct	
		OR_r	Logical Alarm 1 OR 2, Reverse	
Linear Output 1 Range	LYP1	0.5	0 – 5 V DC output 1	0.10
		0.10	0 – 10 V DC output	
		2.10	2 – 10 V DC output	
		0.20	0 – 20 mA DC output	
		4.20	4 – 20 mA DC output	
Retransmit Output 1 Scale maximum	ro1H		-1999 to 9999 (display value at which output will be maximum)	Range max
Retransmit Output 1 Scale minimum	ro1L		-1999 to 9999 (display value at which output will be minimum)	Range min
Output 2 Usage	USE2		As for output 1	Sec or AI2
Lin. O/P 2 Range	LYP2			0.10
Retransmit Output 2 Scale maximum	ro2H		-1999 to 9999 (display value at which output will be maximum)	Range max
Retransmit Output 2 Scale minimum	ro2L		-1999 to 9999 (display value at which output will be minimum)	Range min
Output 3 Usage	USE3		As for output 1	AI_d
Linear Output 3 Range	LYP3			0.10
Retransmit Output 3 Scale maximum	ro3H		-1999 to 9999 (display value at which output will be maximum)	Range max
Retransmit Output 3 Scale minimum	ro3L		-1999 to 9999 (display value at which output will be minimum)	Range min
Display Strategy	dISP		1, 2, 3, 4, 5 or 6 (refer to section 7)	1
Comms Protocol	Prot	ASC1	ASCII	r7bn
		r7bn	Modbus with no parity	
		r7be	Modbus with Even Parity	
	r7bo	Modbus with Odd Parity		
Bit rate	bAud	1.2	1.2 kbps	4.8
		2.4	2.4 kbps	
		4.8	4.8 kbps	
		9.6	9.6 kbps	
		19.2	19.2 kbps	
Comms Address	Addr	1	1 – 255 (Modbus), 1-99 (ASCII)	1
Comms Write	CoEn		Read only or read/write	r_w
Digital Input Usage	dIG	d IS1	Setpoint 1 / Setpoint 2 select	d IS1
		d IS5	Automatic / Manual select	
Config Lock Code	CLoc		0 to 9999	20

Note: Refer to the full user guide (available from your supplier) for further details on these parameters.

ISE, Inc. - Cleveland, OH
(440) 237-3200
To download the complete manual:
<http://6100plus.com>





Code	Input Type & Range	Code	Input Type & Range	Code	Input Type & Range
bC	B: 100 – 1824 °C	LC	L: 0.0 – 537.7 °C	P24F	PIRH20% vs 40%: 32 – 3362 °F
bF	B: 211 – 3315 °F	LF	L: 32.0 – 999.9 °F		
cC	C: 0 – 2320 °C	NC	N: 0 – 1399 °C	PtC	PT100: -199 – 800 °C
cF	C: 32 – 4208 °F	NF	N: 32 – 2551 °F	PtF	PT100: -328 – 1472 °F
Jc	J: -200 – 1200 °C	rc	R: 0 – 1759 °C	PtC	PT100: -128.8 – 537.7 °C
JF	J: -328 – 2192 °F	rF	R: 32 – 3198 °F	PtF	PT100: -199.9 – 999.9 °F
Jc	J: -128.8 – 537.7 °C	Sc	S: 0 – 1762 °C	0.20	0 – 20 mA DC
JF	J: -199.9 – 999.9 °F	SF	S: 32 – 3204 °F	4.20	4 – 20 mA DC
Kc	K: -240 – 1373 °C	Tc	T: -240 – 400 °C	0.50	0 – 50 mV DC
KF	K: -400 – 2503 °F	Tf	T: -400 – 752 °F	10.50	10 – 50 mV DC
Kc	K: -128.8 – 537.7 °C	Tc	T: -128.8 – 400.0 °C	0.5	0 – 5 V DC
KF	K: -199.9 – 999.9 °F	Tf	T: -199.9 – 752.0 °F	1.5	1 – 5 V DC
Lc	L: 0 – 762 °C	P24C	PIRH20% vs 40%: 0 – 1850 °C	0.10	0 – 10 V DC
LF	L: 32 – 1403 °F		2.10	2 – 10 V DC	

4. SETUP MODE

Note: Configuration must be completed before adjusting Setup parameters.
First select Setup mode from Select mode (refer to section 2). While in Setup Mode  is lit. Press  to scroll through the parameters, then press  to set the required value. To exit from Setup mode, hold down  and press  to return to Select mode.
Note: Parameters displayed depends on how instrument has been configured.

Parameter	Lower Display	Upper Display Adjustment Range	Default
Input Filter Time constant	F.iLT	OFF or 0.5 to 100.0 secs	2.0
Process Variable Offset	OFF5	+/- Span of controller	0
Primary (Heat) power	PPWJ	Current power levels (read only)	N/A
Secondary (Cool) power	SPWJ		
Primary Proportional Band	Pb.P	0.0% (ON/OFF) and 0.5% to 999.9% of input span.	10.0
Secondary Proportional Band	Pb.S		
Automatic Reset (Integral Time)	ARSt	1 sec to 99 mins 59 secs and OFF	5.00
Rate (Derivative Time)	rAtE	00 secs to 99 mins 59 secs	1.15
Overlap/Deadband	OL	-20 to +20% of Primary and Secondary Proportional Band	0
Manual Reset (Bias)	b.rAS	0% (-100% if dual control) to 100%	25
Primary ON/OFF Differential	d.rFP	0.1% to 10.0% of input span centered about the setpoint	0.5
Secondary ON/OFF Diff.	d.rFS		
Prim. & Sec. ON/OFF Diff.	d.rFF		
Setpoint Upper Limit	SPUL	Current Setpoint to Range max	R/max
Setpoint Lower limit	SPLL	Range min to Current Setpoint	R/min
Primary Output Power Limit	OPUL	0% to 100% of full power.	100
Output 1 Cycle Time	Ct1	0.5, 1, 2, 4, 8, 16, 32, 64, 128, 256 or 512 secs.	32
Output 2 Cycle Time	Ct2		
Output 3 Cycle Time	Ct3		
High Alarm 1 value	PhA1	Range Min. to Range Max.	R/max
Low Alarm 1 value	PLA1		R/min
Deviation Alarm 1 Value	dAL1	+/- Span from SP in display units	5
Band Alarm 1 value	bAL1	1 LSD to span from setpoint	5
Alarm 1 Hysteresis	AHY1	1 LSD to full span in display units	1
High Alarm 2 value	PhA2	Range Min. to Range Max.	R/max
Low Alarm 2 value	PLA2		R/min
Deviation Alarm 2 Value	dAL2	+/- Span from SP in display units	5
Band Alarm 2 value	bAL2	1 LSD to span from setpoint	5
Alarm 2 Hysteresis	AHY2	1 LSD to full span in display units	1
Loop Alarm Time	LAt	1 sec to 99 mins. 59secs.	99.59
Auto Pre-tune	APt		
Auto/manual Control selection	PoEn	disabled or enabled	d.rSA
Setpoint ramping	SPr		
SP Ramp Rate Value	rP	1 to 9999 units/hour or Off (blank)	Off
SP Value	SP	Scale range upper to lower limits	Scale Range min
SP1 Value	SP1	Scale range upper to lower limits	
SP2 Value	SP2	"_" indicates currently active SP.	
Setup Lock Code	SLoc	0 to 9999	10



5. AUTOMATIC TUNING MODE

First select Automatic tuning mode from Select mode (refer to section 2). Press  to scroll through the modes, then press  to set the required value. To exit from Automatic tuning mode, hold down  and press  to return to Select mode. Pre-tune is a single-shot routine and is thus self-disengaging when complete. If **APt** in Setup mode = **EnAb**, Pre-tune will attempt to run at every power up*. Refer to the full user guide (available from your supplier) for details on controller tuning.

Parameter	Lower Display	Upper Display Adjustment Range	Default
Pre-Tune	Ptun	On or OFF. Indication remains OFF if automatic tuning cannot be used at this time*.	OFF
Self-Tune	Stun		
Tune Lock	tLoc	0 to 9999	0



* Note: Automatic tuning will not engage if either proportional band = 0. Also, Pre-tune will not engage if setpoint is ramping, or the PV is within 5% of span of the setpoint.

6. PRODUCT INFORMATION MODE

First select Product information mode from Select mode (refer to section 2). Press  to view each parameter. To exit from Product Information mode, hold down  and press  to return to Select mode. Note: These parameters are all read only.

Parameter	Lower Display	Upper Display	Description
Input type	In_1	Un_1	Universal input only
Option 1 module type fitted	OPn1	nonE	No option fitted.
		rLY	Relay
		SSr	SSR drive
		tr_1	Triac
Option 2 type fitted	OPn2	L_n	Linear voltage / Current output
Option 3 type fitted	OPn3		As Option 1.
Auxiliary Option module type fitted	OPnR	nonE	No option fitted
		r485	RS485 comms
		d.i.i	Digital Input
Firmware type	FwJ		Value displayed is firmware type number
Firmware issue	ISS		Value displayed is firmware issue number
Product Revision Level	P.rL		Value displayed is Product Revision level.
Date of manufacture	dOrM		Manufacturing date code (mmyy)
Serial number 1	Sn1		First four digits of serial number
Serial number 2	Sn2		Middle four digits of serial number
Serial number 3	Sn3		Last four digits of serial number



7. OPERATOR MODE

This mode is entered at power on. It can also be accessed from Select mode (see section 2). **Note: All configuration mode and Setup mode parameters must be set as required before starting normal operations.** Press  to scroll through the parameters, then press  to set the required value. **Note: All parameters in Display strategy 6 are read only, and can only be adjusted via Setup mode.**





Upper Display	Lower Display	Display Strategy When Visible	Description
PV Value	Active SP Value	1 & 2 (initial screen)	PV and target value of selected SP <i>SP adjustable in Strategy 2</i>
PV Value	Actual SP Value	3 & 6 (initial screen)	PV and actual value of selected SP (e.g. ramping SP value). <i>Read only</i>
PV Value	(Blank)	4 (initial screen)	Process variable only. <i>Read only</i>
Active SP Value	(Blank)	5 (initial screen)	Target value of selected setpoint only. <i>Read only</i>
SP Value	SP	1, 3, 4, 5 & 6 if digital input is not d.i.i	Target value of SP <i>Adjustable except in Strategy 6</i>
SP1 Value	SP1	"_" if dig I/P = d.i.i and active SP is SP1	Target value of SP1 <i>Adjustable except in Strategy 6</i>
SP2 Value	SP2	"_" if dig I/P = d.i.i and active SP is SP2	Target value of SP2 <i>Adjustable except in Strategy 6</i>
Actual SP Value	SP.rP	SP.r enabled and rP is not zero	Actual (ramping) value of selected SP <i>Read only</i>
Ramp Rate	rP	SP.r enabled in Setup mode	SP ramping rate, in units per hour. <i>Adjustable except in Strategy 6</i>

Upper Display	Lower Display	Display Strategy When Visible	Description
Active Alarms	ALSt	When one or more alarms are active.  ALM indicator will also flash	Alarm 2 active Alarm 1 active Loop Alarm active

Manual Control

If **PoEn** is set to **EnAb** in Setup mode, manual control can be selected/de-selected by pressing the  key while in Operator mode, or by changing the status of the digital input if **d.i.i** has been configured for **d.rAS** in Configuration mode. The  indicator will flash while in Manual Control mode and the lower display will show P.xxx (where xxx is the current manual power level). Switching to/from manual mode is via Bumpless Transfer. Press  to set the required output power. **Caution: Not restricted by OPUL limit.**

8. ERROR/FAULT INDICATIONS

Parameter	Upper Display	Lower Display	Description
Instrument parameters are in default conditions	GoTo	Conf	Configuration & Setup required. Seen at first turn on or if hardware configuration changed. Press  to enter the Configuration Mode, next press  or  to enter the unlock code number, then press  to proceed.
Over Range	rHHJ	Normal	Input > 5% over-range
Under Range	rLLJ	Normal	Input > 5% under-range
Sensor Break	OPEN	Normal	Break in input sensor or wiring
Option 1 Error	Err	OPn1	Option 1 module fault
Option 2 Error		OPn2	Option 2 module fault
Option 3 Error		OPn3	Option 3 module fault
Option A Error		OPnR	Auxiliary Option module fault

9. SERIAL COMMUNICATIONS

Refer to the full user guide (available from your supplier) for details of this option.

10. SPECIFICATIONS

UNIVERSAL INPUT

Impedance: >10MΩ resistive, except DC mA (5Ω) and V (47kΩ).
Isolation: Isolated from all outputs (except SSR) at 240VAC.

DIGITAL INPUT

Volt-free(or TTL): Open(2-24VDC) = SP1 or Auto, Closed(<0.8VDC) = SP2 or Manual.

OUTPUTS

Relay

Contact Type/Rating: Single pole double throw (SPDT); 2A resistive at 120/240VAC.
Lifetime: >500,000 operations at rated voltage/current.
Isolation: Isolated from input and other outputs.

SSR Drive/TTL

Drive Capability: SSR >10V into 500Ω min.
Isolation: Not isolated from input or other SSR drive outputs.

Triac

Operating Voltage: 20 - 280Vrms (47 - 63Hz)
Current Rating: 0.01 - 1A (full cycle rms on-state @ 25°C); derates linearly above 40°C to 0.5A @ 80°C.

Isolation:

Isolated from input and other outputs.

DC

Resolution: 8 bits in 250ms (10 bits in 1s typical, >10 bits in >1s typical).
Isolation: Isolated from input and other outputs.

OPERATING CONDITIONS FOR INDOOR USE

Ambient Temperature: 0°C to 55°C (Operating)
Ambient Temperature: -20°C to 80°C (Storage)
Relative Humidity: 20% - 95% non-condensing
Supply Voltage: 100 - 240VAC 50/60Hz 7.5VA for mains powered versions.
20 - 48VAC 50/60Hz (option) 7.5VA or 22 - 65VDC 5W maximum for low voltage versions

ENVIRONMENTAL

Standards: CE, UL, ULC
EMI: Complies with EN61326 (Susceptibility & Emissions)
Safety Considerations: Complies with EN61010-1 & UL3121
Pollution Degree 2, Installation Category II

Front Panel Sealing:

To IP66

PHYSICAL

Dimensions Depth: 110mm (behind panel)
Front panel height: 48mm
Front panel width: 48mm
Weight: 0.21kg maximum