

# User's Handbook for the UNISTAR Sx SERIES UPS

---



301 Gaddis Blvd. • Dayton, Ohio 45403  
(937) 253-1191 • Fax: (937) 253-1723  
web site: [www.stacoenergy.com](http://www.stacoenergy.com)

## TABLE OF CONTENTS

1	INTRODUCTION .....	1
2	CONTROLS AND INDICATORS .....	3
3	INSTALLATION .....	5
4	OPERATION .....	10
5	TROUBLESHOOTING .....	14
6	REPLACING THE BATTERY .....	17
7	OBTAINING SERVICE .....	21
8	SPECIFICATIONS .....	22
9	CONFIGURABLE PARAMETERS AND SETTINGS .....	23
10	LIMITED PRODUCT WARRANTY .....	25

# 1 INTRODUCTION

Thank you for purchasing a Staco Energy Products power protection product. It has been designed and manufactured to provide many years of trouble free service.

**IMPORTANT SAFETY INSTRUCTIONS  
SAVE THESE INSTRUCTIONS!**

Please read the manual before installing your UPS. It provides the information that should be followed during installation and maintenance of the UPS and the batteries allowing you to correctly set up your system for the maximum safety and performance. Included is information on customer support and factory service if it is required. If you experience a problem with the UPS please refer to the Troubleshooting guide in this manual to correct the problem or collect enough information so that the Staco Energy Products Customer Service Department can rapidly assist you.



**This symbol indicates "ATTENTION"**



**This symbol indicates "Risk of Electrical Shock"**



**NOTICE:** This equipment has been tested and found to comply with the limits for a Class A computing device in accordance with the specifications in Subpart J of Part 15 of FCC Rules and the Class B limits for radio noise emissions from digital apparatus set out in the Radio Interference of the Canadian Department of Communications. These limits are designed to provide reasonable protection against such interference in a residential installation. This equipment generates and uses radio frequency and if not installed and used properly, that is, in strict accordance with the manufacturer's instructions, this equipment may cause interference to radio and television reception. If this equipment does cause interference to radio or television reception, which can be determined by turning the equipment off and on, the user is encouraged to try to correct the interference by one or more of the following measures:

- n Re-orient the receiving antenna
- n Relocate the computer with respect to the receiver
- n Move the computer away from the receiver
- n Plug the computer into a different outlet so that the computer and receiver are on different branch circuits.
- n Shielded communications interface cables must be used with this product



**WARNING:** Changes or modifications to this unit not expressly approved by the party responsible for compliance could void the user's authority to operate the equipment.

## Receiving Inspection

After removing your Staco, Unistar Sx UPS from it's carton, it should be inspected for damage that may have occurred in shipping. Immediately notify the carrier and place of purchase if any damage is found. Warranty claims for damage caused by the carrier will not be honored.

The packing materials that your UPS was shipped in, are carefully designed to minimize any shipping damage. In the unlikely case that the UPS needs to be returned to Staco Energy Products, please use the original packing material. Since Staco Energy Products is not responsible for shipping damage incurred when the system is returned, the original packing material is inexpensive insurance. **PLEASE SAVE THE PACKING MATERIALS!**



**WARNING: RISK OF ELECTRICAL SHOCK. HAZARDOUS LIVE PARTS INSIDE THIS POWER SUPPLY ARE ENERGIZED FROM THE BATTERY EVEN WHEN THE AC INPUT POWER IS DISCONNECTED.**

TO DE-ENERGIZE THE OUTPUTS OF THE UPS:

1. IF THE UPS IS ON PRESS THE ON/OFF BUTTON FOR 1 SECOND
2. DISCONNECT THE UPS FROM THE AC POWER OUTLET
3. TO DEENERGIZE THE UPS COMPLETELY, DISCONNECT THE BATTERY.

**THIS UNINTERRUPTIBLE POWER SOURCE CONTAINS POTENTIALLY HAZARDOUS VOLTAGES. DO NOT ATTEMPT TO DISASSEMBLE THE UNIT. THIS UPS CONTAINS NO USER SERVICEABLE PARTS. REPAIRS AND BATTERY REPLACEMENT MUST BE PERFORMED BY AUTHORIZED SERVICE PERSONNEL ONLY.**



**CAUTION!** TO REDUCE THE RISK OF ELECTRICAL SHOCK IN CONDITIONS WHERE LOAD EQUIPMENT GROUNDING CANNOT BE VERIFIED, DISCONNECT THE UPS FROM THE AC POWER OUTLET BEFORE INSTALLING A COMPUTER INTERFACE CABLE. RECONNECT THE POWER CORD ONLY AFTER ALL SIGNALING CONNECTIONS ARE MADE.



**CAUTION!** CONNECT THE UPS TO A TWO POLE, THREE WIRE GROUNDING AC POWER OUTLET. THE RECEPTACLE MUST BE CONNECTED TO APPROPRIATE BRANCH PROTECTION (CIRCUIT BREAKER OR FUSE). CONNECTION TO ANY OTHER TYPE OF RECEPTACLE MAY RESULT IN A SHOCK HAZARD AND VIOLATE LOCAL ELECTRICAL CODES

### **Staco Energy Products Co. Life Support Policy**

As a general policy, Staco Energy Products Co. does not recommend the use of any of its products in life support applications where failure or malfunction of the Staco Energy product can be reasonably expected to cause failure of the life support device or to significantly affect its safety or effectiveness. Staco Energy Products does not recommend the use of any of its products in direct patient care. Staco Energy Products will not knowingly sell its products for use in such applications unless it receives in writing assurances satisfactory to Staco Energy Products that (a) the risks of injury or damage have been minimized, (b) the customer assumes all such risks, and (c) the liability of Staco Energy Products Co. is adequately protected under the circumstances.

Examples of devices considered to be life support devices are neonatal oxygen analyzers, nerve stimulators (whether used for anesthesia, pain relief, or other purposes), auto transfusion devices, blood pumps, defibrillators, arrhythmia detectors and alarms, pacemakers, hemodialysis systems, peritoneal dialysis systems, neonatal ventilator incubators, ventilators for both adults and infants, anesthesia ventilators, and infusion pumps as well as any other devices designated as "critical" by the United States FDA.

Hospital grade wiring devices and leakage current may be ordered as options on many Staco Energy Products UPS systems. Staco Energy Products Co. does not claim that units with this modification are certified or listed as Hospital Grade by Staco Energy Products or any other organization. Therefore, these units do not meet the requirements for use in direct patient care.

## 2 CONTROLS AND INDICATORS

### FRONT PANEL (LCD Units)



Primary Power Switch: Press and release the ON/OFF button to turn the unit ON or OFF.



Normal Mode Icon: This icon will illuminate when the utility power is within safe operating range.



Battery Mode Icon: This icon will illuminate when the Utility power is outside safe operating range and the unit is operating in the battery mode.



Bypass Mode Icon: This icon will illuminate when the unit is in bypass mode and you do not have battery backup protection.



Unit Fault Icon: The Fault icon illuminates when the UPS has detected an internal fault. (see section 5)



Unit Fault Icon: This icon and error code will illuminate when the self diagnostics are able to determine the problem.



Unit Charger Icon: This icon will illuminate when the unit is charging the batteries.



Unit Overload Icon: This icon will illuminate when the unit load has exceeded the rating of the UPS. The UPS will transfer to bypass mode if the overload is not removed.

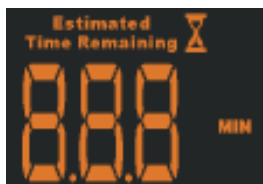

Estimated Time Remaining icons: These combination of LCD icons will illuminate when selected and the UPS is operating in the battery mode. The first time icon will appear as ">" if the estimated time remaining is greater than ten (10) minutes. This symbol will turn off when the estimated time remaining is less than 10 minutes and the remaining time will appear in the display.



Unit Audible Alarm Icon: This alarm will illuminate when audible alarm is silenced.



Unit Input Icon: When selected, this will display the selected item for the input from utility.



Unit Output Icon: When selected, this will display the selected item for the output from unit.



Unit Amperage Icon: When selected, this will display the amps from either the input or output based on selection of input or output as described previously.



Unit Voltage Icon: When selected, this will display the voltage from either the input or output based on selection of input or output as described previously.



Unit Frequency Icon: When selected, this will display the frequency from either the input or output based on selection of input or output as described previously.



Unit Load in Watts Icon: When selected, this will display the load from either the input or output based on selection of input or output as described previously.



Unit Battery Percentage Status Icon: When selected, this will display the percentage of battery capability remaining.



Unit Load Percentage Status Icon: When selected, this will display the percentage of load on the unit.

### 3 INSTALLATION

#### INSTALLATION PLACEMENT



Install the UPS in a temperature controlled environment that is free of conductive contaminants. Select a location which will provide good air circulation for the UPS at all times. Avoid locations near heating devices, water or excessive humidity, or where the UPS is exposed to direct sunlight. Route power cords so they cannot be walked on or damaged.

Operating Temperature: 0 to 25°C

Storage Temperature: -15 to +45°C

Operating Elevation: 0 to 3,000 Meters

Storage Elevation: 0 to 15,000 Meters

Operating and Storage Relative Humidity: 95%, non-condensing

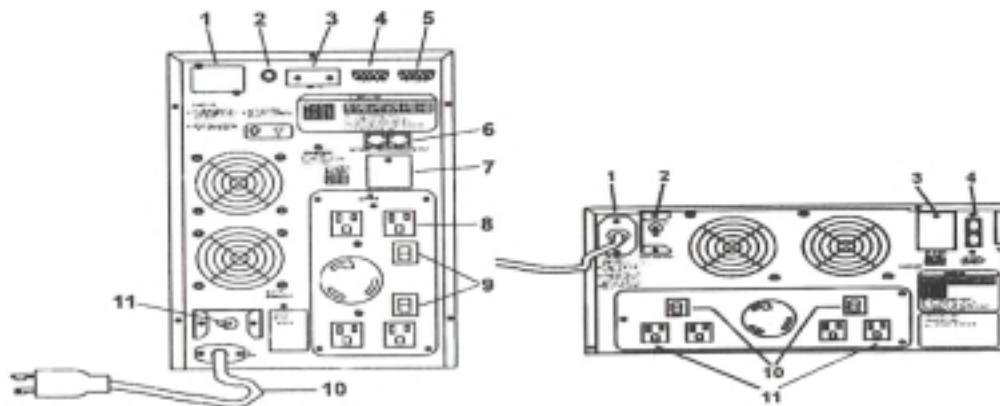

#### REAR PANEL (120Vac models shown)

##### Tower Models

1. Smart slot for optional cards
2. Switch, momentary switch used to change displays or silence alarm
3. Dip switches used to configure unit parameters
4. Simple Communications port (AS400)
5. RS232 intelligent communications port
6. Network protection (lan only)
7. External battery connection point
8. Output load receptacles
9. Output load circuit breakers
10. Incoming utility power cord
11. Incoming utility circuit breaker

##### Rackmount Models

1. Incoming utility power cord
2. Incoming utility circuit breaker
3. External battery connection point
4. Network protection (lan only)
5. Smart slot for optional cards
6. Switch, momentary switch used to change displays or silence alarm
7. Dip switches used to configure unit parameters
8. Simple Communications port (AS400)
9. RS232 intelligent communications port
10. Output load circuit breakers
11. Output load receptacles

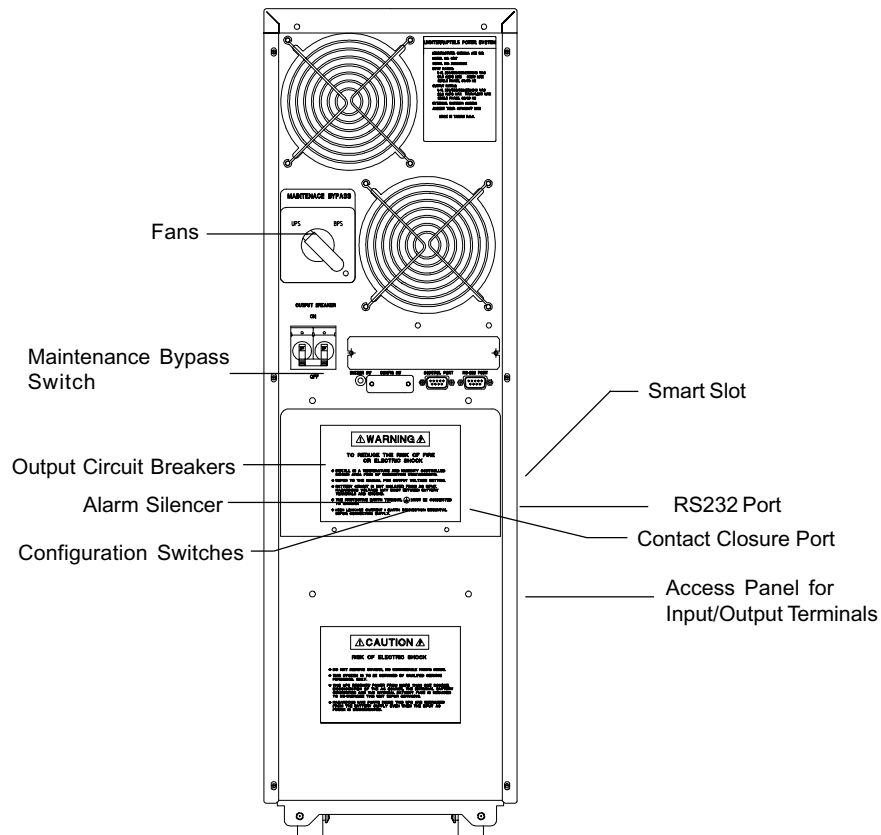

## SB50002 and SB70002

Fans: Internal Cooling Fans.

Maintenance Bypass Switch: In normal operation the switch must be in the UPS position. When doing routine maintenance the switch must be in the BPS position.

Output Circuit Breakers: Turn OFF/ON the output of the UPS.

Alarm Silencer: Silences the Alarm in the Battery Mode.

Configuration Switches: Must be set before turning the UPS ON (see page 11).

Smart Slot: For Optional Cards.

RS232 Port: Intelligent Communications Port.

Contact Closure Port: Simple Communications Port (AS400).

Access Panel for Input/Output Terminals: Remove the panel for Input/Output Connections.



## INSTALLATION

(Must be performed by Authorized Service Personnel ONLY)

Be sure to read the installation placement and all the cautions before installing the UPS. The MCP-E series UPS has external Battery Pack capability, please observe the following warning when connecting the Battery Pack(s). **WARNING!** DO NOT PLUG THE BATTERY PACK'S CONNECTOR INTO THE UPS'S BATTERY CONNECTOR WHILE THE UPS IS TURNED ON.

**NOTE:** The red connectors/wires are the battery positive(+) and the black connectors/wires are the battery negative(-) on all Staco, Unistar Sx UPS configurations.

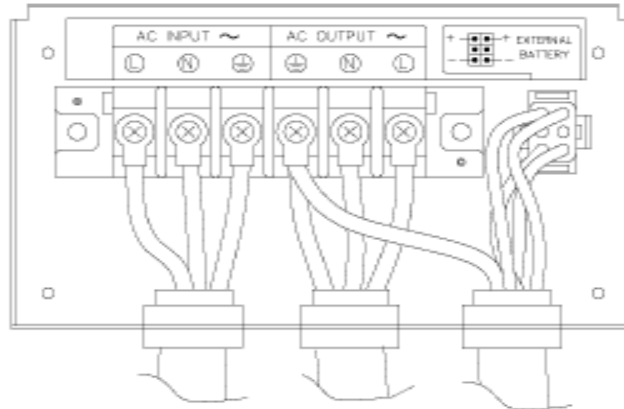

### SB50002 and SB70002 Input/Output/Battery Pack Connections

(Must be performed by Authorized Service Personnel ONLY)

Installation instructions for hardwiring the Input/Output Connections and connecting an external Battery Pack:

1. Remove the access panel on the rear panel of the UPS.
2. Push the input cable through the grommet nearest the input terminal block.
3. Connect L1 to the AC Input's "L" terminal, connect L2 to the AC Input's "N" terminal, connect AC ground to the AC Input's ground terminal. Be sure that all connects are secured tightly.
4. Push the output cable through the grommet nearest the output terminal block.
5. Connect L1 to the AC Output's "L" terminal, connect L2 to the AC Output's "N" terminal, connect AC ground to the AC Output's ground terminal. Be sure that all connections are tightly secured.
6. Push the external Battery Pack's cable through the grommet nearest the external Battery Pack connector.
7. Connect the external Battery Pack's Mat-Lok connector to the external Battery Pack connector. Connect the external Battery Pack's AC ground to the AC Output's AC ground terminal. Be sure that all connections are tightly secured.
8. Reinstall the access panel on the rear panel of the UPS.
9. Now the UPS is ready for the normal start-up procedure.

**NOTE:** The SB50002 and SB70002's AC input must be connected to an AC circuit breaker which will provide for an emergency power off. (Must be performed by Authorized Service Personnel ONLY).

Model	SB50002	SB70002
Input Circuit Breaker	40 Amp	50 Amp
Input Wire Size/Temp	8 AWG/105°C	6 AWG/105°C
Wire Conductor	Three conductor, copper wire only	
Tightening torque for pressure wire connectors having screws	Torque 17.6 lbs (8kg)	

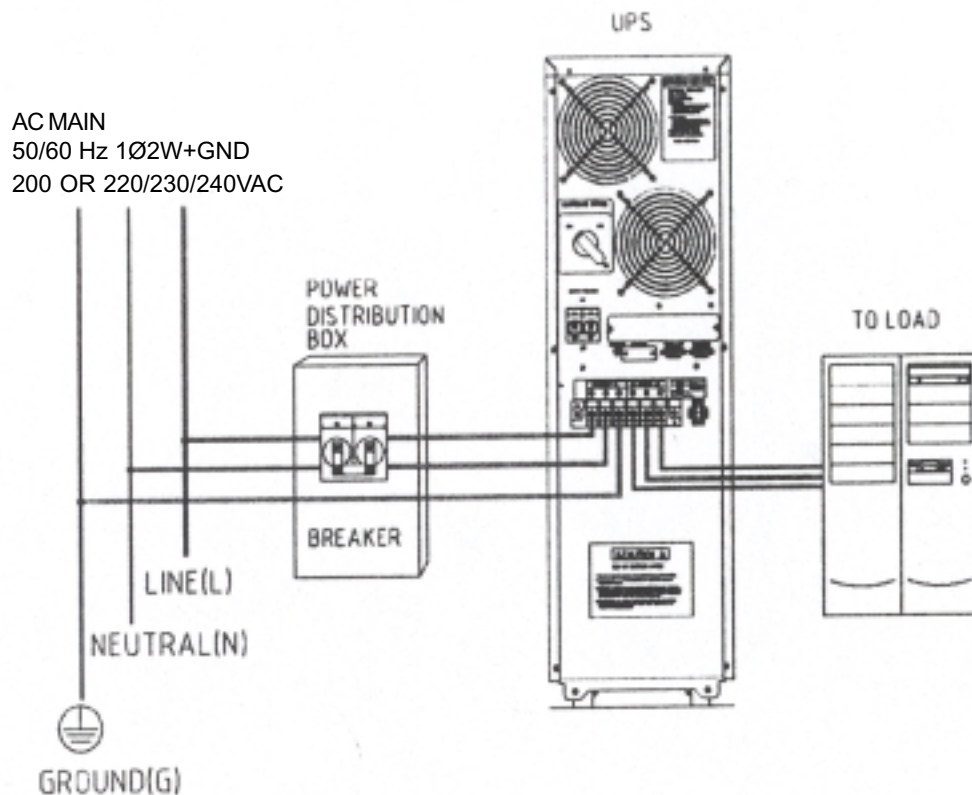

Block diagram of the SB50002 and SB70002 input and output wiring.

The Unistar Sx Series UPS can be installed in two different configurations. The Tower Model allows the user to install the UPS next to the tower computer. Use **CAUTION**, the UPS is extremely heavy. Place the UPS in the final desired location and complete the rest of the installation procedure. Now the UPS is ready for the normal start-up procedure.

The Rackmount Configuration comes with mounting brackets for the standard 19" (46.5cm) rack. The mounting brackets to fit a 23" (59.2cm) standard rack are also available. The screws for mounting the UPS to the rack are not included (screw size varies with rack size). The kit includes, two mounting brackets and four retaining screws. Locate the mounting bracket screw holes on the side panels of the UPS, at the front of the UPS. Align the mounting bracket with the mounting bracket screw holes. Attach the mounting bracket with the retaining screws. **WARNING:** Use two or more people when installing the UPS into the rack. Use caution, the UPS is extremely heavy. Do not move the rack after the units have been installed. The rack may be unstable due to the weight distribution. Now the UPS is ready for the normal start-up procedure.

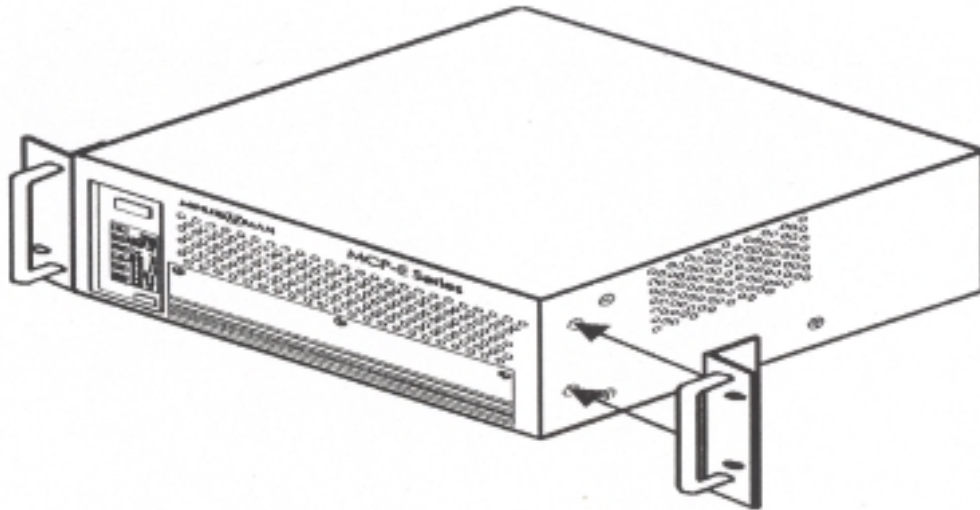

### **CONNECTING TO AN AC SOURCE**

Plug the UPS into a two pole, three wire, grounded receptacle only. Do not use extension cords or adapter plugs. The SB50002 and SB70002 must be hardwired (see page 7).

### **COMPUTER INTERFACE CONNECTION (OPTIONAL)**

MINUTEMAN Power Management software and interface cables kits can be used with the MCP-E units. Use only Staco approved interface cables with these UPS's. Connect the interface cable to the 9 pin computer interface port on the rear of the UPS. Secure the connector to the UPS via the screws on the connector housing. Connect the other end of the cable to the device that will be monitoring/controlling the UPS.

**NOTE:** Connecting to the computer interface port is optional. The UPS works properly without this connection.

**NETWORK SURGE PROTECTION CONNECTION (OPTIONAL)**

Connect a 10 Base-T network line to the protection sockets on the rear of the UPS (not available on all models). This connection will require another length of network cable. The cable coming from the networked system is connected to the port marked "IN". The "OUT" port is connected to the equipment to be protected.

NOTE: Connecting to the Network Surge Protection connection is optional. The UPS works properly without this connection.

**CONNECTING YOUR EQUIPMENT**

Plug the equipment into the output receptacles on the back panel of the unit. Do not use extension cords, adapter plugs, power strips or surge strips. The SB50002 and the SB70002 are hardwire output connections only, be sure the output breaker is in the ON position. Insure that you do not exceed the maximum output rating of the UPS (refer to the UPS's back panel or the Electrical Specifications in this manual).

 **CAUTION! DO NOT CONNECT A LASER PRINTER TO THE BATTERY BACKUP RECEPTACLES ON THE UPS UNLESS THE UPS IS RATED 2000VA OR GREATER. A LASER PRINTER DRAWS SIGNIFICANTLY MORE POWER WHEN PRINTING THAN AT IDLE, AND MAY OVERLOAD THE UPS.**

**4 OPERATION**

**TURNING THE UNIT ON/OFF**

**NOTE:** The UPS is shipped with the unit disabled. Turn dip switch #1 to the ON position before attempting to turn on the unit. This will enable the unit. Set all of the dip switches per the desired setting for your environment prior to turning on the unit. Configuration Switches for the SB07001/2 and SB10001/2. The "System Enable" switch must be enabled for the UPS to operate.

System	SW1	On=Enable	Off=Disable		
Freq (Cold Start)	SW2	On=60Hz	Off=50Hz		
Output Voltage Select	SW3	Off	Off	On	On
	SW4	Off	On	Off	On
		100V	110V	115V	120V

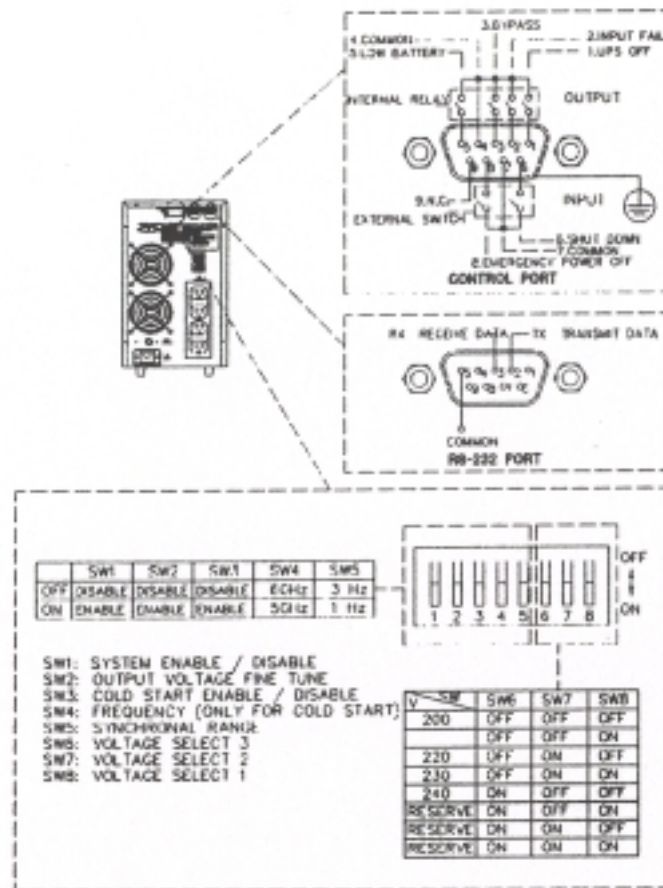

SB20001/2 and SB30001/2. RS232 Port, Control Port pinouts and Configuration Switches. Configuration Switches for the SB 2000/3000/5000/7000. The "System Enable" switch must be enabled for the UPS to operate.

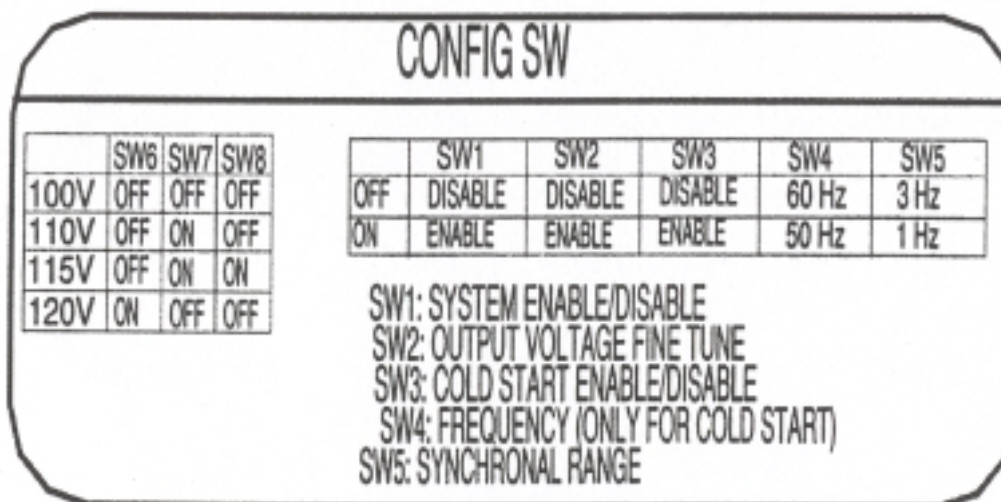

Place your unit in the desired location for use. Connect all equipment power cords to the receptacles on the rear of the UPS. Please insure you confirm total power requirements and do not overload the units.



Press and release the main power switch on the front of the unit to turn on the unit. Press and release again to turn off the unit. Some models have a circuit breaker on the rear panel that must be turned ON first and then press the front panel switch to turn the unit ON.

The unit will turn on, perform a self diagnostic test, switch to bypass mode and then turn on to full inverter mode automatically.

## **ALARMS**

### ON BATTERY

When the UPS is operating in the battery mode, the Battery Mode Icon will illuminate and the audible alarm will sound every 10 seconds. The alarm will stop and the Battery Mode Icon will extinguish once the UPS returns to AC normal operation.

### UPS FAULT

When the UPS detects a fault, the Unit Fault Icon will illuminate and the UPS will emit a sustained tone. The unit will also display a failure code if available. (see section 5 Troubleshooting for failure code definition)

### OVERLOAD

When the amount of load attached to the UPS exceeds its power rating, the Unit Overload Icon will illuminate and the UPS will emit a sustained tone. This alarm will remain on until the excess load is removed or the UPS's self protection circuit takes control. If the unit self protection circuit takes control, the unit will switch to bypass mode until the overload is removed. If the load is excessive, the input circuit breaker will open and the unit will shut down.

### REPLACE BATTERY

The UPS automatically tests the battery's condition and will illuminate the Unit Battery Icon and emit a short beep. This tone will be repeated every hour until the batteries passes a self test. It is recommended that the UPS be allowed to charge overnight before performing a battery test to confirm a Weak/Bad Battery condition.

### LOW BATTERY WARNING

The UPS will emit two consecutive beeps every five seconds when the battery reserve runs low. This continues until AC returns or the UPS shuts down from battery exhaustion.

## **COMMUNICATIONS PORT**

Communications port information for 700VA and 1000VA units only:

The communications port is a standard DB9 female with both RS232 and relay contact closure capability. The units will poll the port and activate the port for RS232 or contact closure in accordance with the type of cable it finds connected to the port. To change the port configuration requires the unit be turned off and restarted with the desired cable connected. The pinout for the port is depicted per the chart below.

- Pin 1: Instant off ( pull and hold this pin low to turn off output receptacles)
- Pin 2: /TXD
- Pin 3: /RXD and receive ups shutdown command
- Pin 4: AC fail, NO closes on event
- Pin 5: Ground
- Pin 6: Low battery warning, NO closes on event
- Pin 7: Common return for all relays
- Pin 8: Summary alarm, NO closes on AC fail, low battery warning, overload, UPS failure or unit on bypass
- Pin 9: Not Used

Communications port information for 2KVA, 3KVA, 5KVA and 7KVA units only:

These units contain two independent communications ports. Port one is for standard RS232 communications and labeled RS-232 Port. The second port is relay contact closure configured for standard AS 400 ports. This port is labeled Control Port.

The pinout for the RS-232 port is depicted per the chart below. Note: when using the SNMP option card, this port will be disconnected. Both the slot and the port may not be used at the same time.

Communication settings: When using the RS232 port, the following settings should be used.

Baud Rate: 2400

Data Bits: 8

Stop Bits: None

Parity: 1

Pin 1: Not Used

Pin 2: /TXD Transmit Data

Pin 3: /RXD Receive Data and Commands

Pin 4: Not Used

Pin 5: Ground

Pin 6: Not Used

Pin 7: Not Used

Pin 8: Not Used

Pin 9: Not Used

The pinout for the Control port is depicted per the chart below.

Pin 1: UPS failure (fault)

Pin 2: Summary alarm (normally open, closes on event)

Pin 3: Common for pin 4

Pin 4: EPO or shutdown

Pin 5: Common ground for all relays.

Pin 6: Bypass active=make/ ups on=open

Pin 7: Battery low (normally open, closes on event)

Pin 8: UPS on=make/ bypass active=open

Pin 9: AC fail (normally open, closes on event)

Your UPS unit is shipped standard with SentryII monitoring software. This software may be used for monitoring the UPS and power when loaded into your computer and connected via the supplied software communication cable. This software is an detailed tool to help you manage your power needs.

This software will also support a simpler style of controlled shutdown for the consumer that is not interested in detail, but is still interested in a controlled unattended shutdown. The simple software function requires the purchase and installation of a separate cable that is not provided with the unit. Please contact your local vendor or Customer Service support department at 866-261-1191 or 937-253-1191 should you need to purchase this software cable.

## 5 TROUBLESHOOTING

Symptom	Possible Cause	What To Do
E10 is displayed after turning on unit	Configuration dip switch is in the off position	Turn Dip Switch #1 to on position as defined on page 10
When turned on, the unit operates in battery mode only	No AC utility power present and unit Cold start function is enabled	Check utility input power and contact local service company if required to correct utility problem
The unit switches from normal to battery mode frequently	The fluctuation of the input utility voltage or frequency is beyond the present guidelines	Check the input utility condition. Adjust Sync Range to 3 Hz. Contact local service personnel if utility remains bad
The unit switches to bypass mode occasionally and then switches back	The unit may be overloaded periodically by a random load increase	Verify if the load may be affected by a printer or excessive load such as numerous phones etc. remove excessive load to eliminate

### Diagnostic codes for 700VA and 1KVA

The 700VA and 1000VA units use LED displays to notify the User of an error detected by the internal diagnostics system. The letter "E" is assumed and is not displayed on the LED graph. The top row of LED's indicate the first number of the "diagnostic error" code. As an example: if the third LED is illuminated, the first character of the "diagnostic error" code is 3. The second row of LED's indicates the second number in the diagnostic error code. As an example: if the second LED is illuminated, the second character of the "diagnostic error" code is 2. These examples would provide an diagnostic error message of E32 with the "E" assumed for all error codes. A sample of E32 is shown below for your reference.

#### LOAD



#### BATTERY

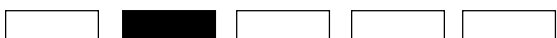

### "EXAMPLE OF DIAGNOSTIC ERROR CODE E32"



If your unit should have a problem, please call our Customer Service department to resolve any issues. Please call, 866-261-1191 or 937-253-1191 and ask for Technical Support. When you call with a problem, please be prepared to provide the following information to the technician.

Model number: example: SB30001

Model Serial number: example: E3026 (5 characters)

Length in Service: example 25 months

Diagnostic code at time of problem: example: E32

Time of day during failure: example: 4:15 am

Weather conditions during failure: example: clear skies, no power problems.

Our Customer Service department is open from 8am -5pm Eastern Standard Time USA Monday - Friday.

Code	Definition
E01	System off resulting from Microprocessor check sum error.
E03	Battery voltage is below safe operating range (AC mode).
E04	Battery voltage has exceeded safe operating range (AC mode).
E05	Thermal sensor is dead or unit exceeds safe temperature.
E10	Configuration dip switch is in the off position.
E13	Input/Output voltage difference is out of 6V specification (AC tracking mode).
E22	+DC bus voltage is out of the range of +15% to -10%.
E23	-DC bus voltage is out of the range of +15% to -10%.
E24	Phase unlocks between input and output.
E32	Power is over 100% for 60 seconds.
E32	Power is over 125% for 10 seconds.
E32	Power is over 150%.
E32	Power is over 300%
E32	RMS current is over 100% for 60 seconds.
E32	RMS current is over 125% for 10 seconds.
E32	RMS current is over 150% for 3 seconds
E32	RMS current is over 300%
E32	Power is over 100% or RMS current is over 100% for 5 seconds (DC mode).
E32	Power is over 125% (DC mode).
E40	Temperature is out of range.
E52	Output senses a short circuit.
E53	Battery test error (battery may be bad or needs charge time).
E55	Input voltage is over 150Vrms for 120vac units.

Diagnostic codes not listed are used by Engineering staff for programming purposes.

## Diagnostic Error Codes for 2KVA, 3KVA, 5KVA, 7KVA units

Error	Description
E00	System ROM check sum error.
E01	System RAM data read/write error.
E02	System EEPROM data read/write error.
E03	Communication fail between CPU & DSP
E05	Temperature over 100°C.
E07	Battery voltage is over specification (AC mode).
E08	Input voltage fail (Outside of safe operating range & cold start disable).
E10	Configure SW1 is set position "OFF".
E11	AC Mode input out of range during normal start-up.
E12	Battery voltage out of range during cold start.
E14	DC bus voltage out of range during cold start.
E15	Output/input voltage difference out of 3.125% (AC tracking mode).
E16	Output/setting voltage difference out of 3.125% (DC mode).
E17	Input frequency fail (Out of 45 ~ 65 Hz) & cold start disable.
E22	DC bus voltage out of range -85% or +12%
E23	Difference between DC bus is more then 70Vdc.
E25	Input / Output frequency difference out of 1Hz during AC mode normal
E26	Battery voltage low (2K-57V, 3K-76V, 5K-190V, 7K-228V) out of range (DC mode)
E32	RMS current over 100%
E33	Voltage difference more than 10% between setting and output
E40	Temperature over 80°C.
E42	Thermal sensor dead.
E53	Battery test error. (battery may be bad)
E54	Line-Neutral connection error.
E60	Transfer fail during AC Bypass to AC Mode
E63	Transfer fail during Battery Mode to normal AC mode.
E67	DC bypass to Battery mode time out in soft start.
E68	AC bypass to Normal mode time out in soft start.
E69	In/out Sync lasts too long.
E78	DIP Switch setting error (output voltage setting).
E80	DSP initial state data transfer error (clear Off).
E81	No response when send data to DSP.
E82	DSP initial state data transfer error (55,aa,version).
E83	Data lost (every cycle received data less than 20 and more than 60 times).
E84	Input voltage break at bypass mode.

## 6 REPLACING THE BATTERY

### REPLACING THE BATTERY

(Must be performed by Authorized Service Personnel ONLY) The Tower Series UPS has a replaceable battery(s), however the unit must be turned off, disconnected from utility and discharged prior to changing the batteries. The Rack Mount Series UPS has a hot swappable battery kit. Please read the following warning statements before attempting to service the battery(s).

**NOTE:** If there is a power interruption while replacing the hot-swappable batteries, with the UPS on, the load will not be backed up.

**WARNING!** This Uninterruptible Power Source contains potentially hazardous voltages. Do not attempt to disassemble the unit. This UPS contains no user serviceable parts. Repairs and Battery replacement must be performed by Authorized Service Personnel ONLY.



**CAUTION:** Do not open or mutilate batteries. Released electrolyte is harmful to the skin and eyes and may be toxic.

**CAUTION:** Do not dispose of batteries in a fire. The batteries May explode.

**WARNING!** The batteries in this UPS are recyclable. Dispose of the batteries properly. The batteries contain lead and pose a hazard to the environment and human health if not disposed of properly. Refer to local codes for proper disposal requirements or return the battery to Minuteman.



Unistar Sx Series Model #	Battery Quantity	Battery Type
SB07001 )2)	3 each	12V7.2AH
SB10001 (2)	3 each	12V7.2AH
SB20001 (2)	6 each	12V7.2AH
SB30001 (2)	8 each	12V7.2AH
SB50002	20 each	12V7.2AH
SB70002	24 each	12V7.2AH

**CAUTION:** System voltages range from 24 VDC to 288 VDC. A battery can present a risk of electrical shock and high short circuit current. The following precautions should be observed when working on batteries:



1. Remove watches, rings, or other metal objects.
2. Use hand tools with insulated handles.
3. Wear rubber gloves and boots.
4. Do not lay tools or other metal parts on top of batteries.
5. Disconnect charging source prior to connecting or disconnecting battery terminals.
6. Determine if the battery is inadvertently grounded. If inadvertently grounded, remove source of the ground. Contact with any part of a grounded battery can result in electrical shock. The likelihood of such shock will be reduced if such grounds are removed during installation and maintenance.

**CAUTION:** Replace batteries with the same number and type as originally installed in the UPS.



These batteries have pressure operated vents. When replacing the batteries, replace with the same number of the:

Manufacturer	Model Number
CSB	GP/FR 12070 F2
YUSA	NP7-12\250
PANASONIC	LCR 12V 7.2S1
HITACHI	HV7-12 F2

These batteries are used in both the UPS and external Battery Packs.

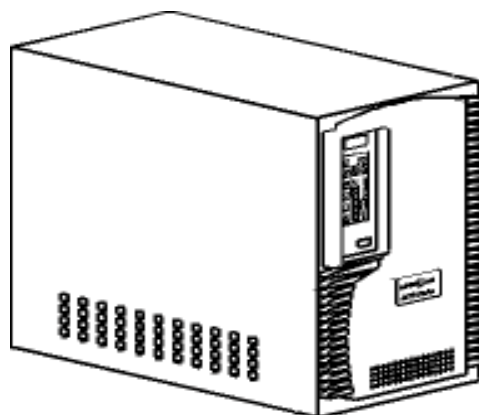

## Battery Replacement Procedure for Tower Model

(Must be performed by Authorized Service Personnel ONLY)

PLEASE READ THE CAUTIONS BEFORE ATTEMPTING TO REPLACE THE BATTERIES  
These units are not hot-swappable. Hot-swappable batteries means that the batteries can be replaced without powering down the whole UPS system.

1. Turn off the equipment that is plugged into the output receptacles of the UPS.
2. Turn off the UPS using the primary power switch on the front.
3. Turn off the AC circuit breaker on the rear panel of the UPS (if applicable).
4. Unplug the UPS's AC power cord from the AC outlet.
5. Unplug the equipment from the output receptacles of the UPS.
6. Remove the cover of the UPS.
7. Disconnect the battery positive (red) wire and the all of the battery jumper wires.
8. Disconnect the battery negative (black) wire.
9. Remove the top four retaining screws and the top battery retaining bracket.

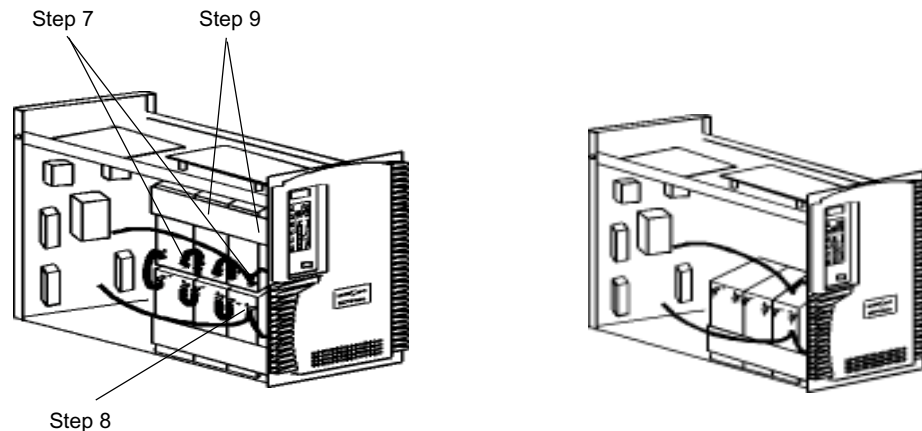

10. Remove the top row of the batteries.
11. Remove the bottom four retaining screws and the bottom battery retaining bracket.
12. Remove the bottom row of the batteries.
13. Install the bottom row of new batteries.
14. Reinstall the bottom battery retaining bracket and the retaining screws.
15. Install the top row of new batteries.
16. Reinstall the top battery retaining bracket and the retaining screws.
17. Reconnect the battery negative (black) wire and the battery jumper wires. Verify proper polarity, negative (black) wire to the battery negative terminal and the battery jumper wires are connected properly.
18. Reconnect the battery positive (red) wire to the battery positive terminal. Some sparking may occur, this is normal.
19. Reinstall the cover on the UPS.
20. Dispose of the batteries properly at an appropriate recycling facility or return them to the supplier in the packing material for the new batteries. Follow local EPA guidelines when disposing of batteries. Note: These batteries contain lead and must be disposed of per environment guidelines.
21. The UPS is now ready for the normal start-up procedure.

## Battery Replacement Procedure for Rack Mount Models

(Must be performed by Authorized Service Personnel ONLY)

### PLEASE READ THE CAUTIONS BEFORE ATTEMPTING TO REPLACE THE BATTERIES

These units are hot-swappable. Hot-swappable batteries means that the batteries can be replaced without powering down the whole UPS system. NOTE: If there is a power interruption while replacing the hot-swappable batteries, with the UPS on, the load will not be backed up.

1. Utilize steps 1-5 from page 18 if you do not want to hot-swap. Then proceed.
2. Remove the three retaining screws from front panel of the UPS.

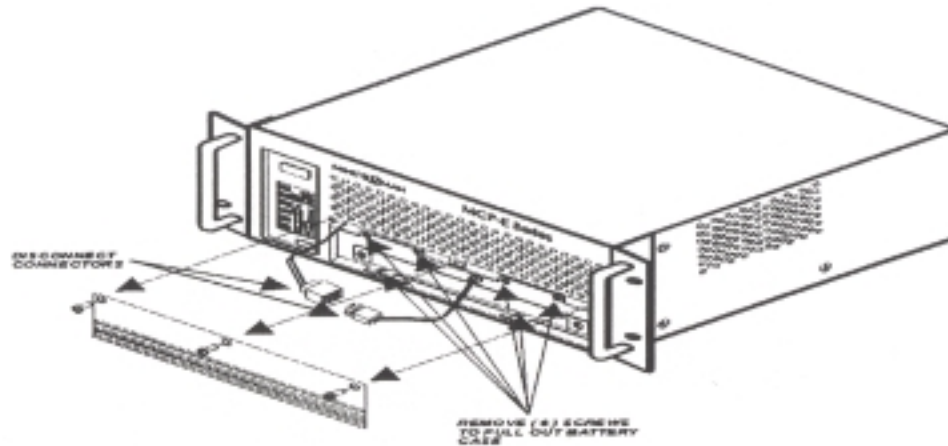

3. Remove the six retaining screws and the battery case retaining bracket.
4. Disconnect the battery wiring harness connector.
5. Remove the battery case.
6. Insert the new battery case.
7. Connect the battery harness connector.
8. Reinstall the battery case retaining bracket and the retaining screws.
9. Reinstall the front panel and the retaining screws.
10. Dispose of the batteries properly at an appropriate recycling facility or return them to the supplier in the packing material for the new batteries. Follow local EPA guidelines when disposing of batteries. Note: These batteries contain lead and must be disposed of per environmental guidelines.
11. The UPS is now ready for the normal start-up procedure if required.

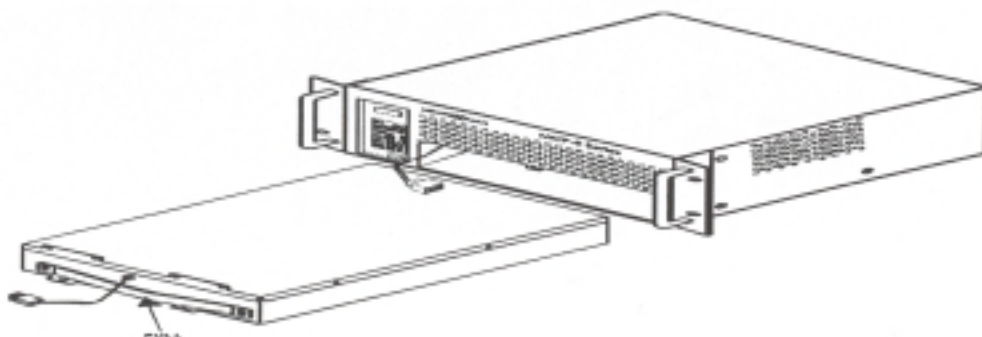

## 7 OBTAINING SERVICE

### IF THE UPS REQUIRES SERVICE

1. Use the TROUBLESHOOTING section to eliminate obvious causes.
2. Verify there are no circuit breakers tripped. A tripped circuit breaker is the most common problem.
3. Call your dealer for assistance. If you cannot reach your dealer, or if they cannot resolve the problem call or fax Customer Service at the following numbers; Voice phone 937-253-1191 ext. 141, FAX line 937-253-1723. Please have the following information available BEFORE calling the Customer Service Department.
  - A. Your Name and address.
  - B. Where and when the unit was purchased.
  - C. Model number: example: SB30001
  - D. Model Serial number: example: E3026 (5 characters)
  - E. Length in Service: example 25 months
  - F. Diagnostic code at time of problem: example: E32
  - G. Time of day during failure: example: 4:15 am
  - H. Weather conditions during failure: example: clear skies, no power problems.
  - I. A description of the protected equipment, including model numbers if possible.
  - J. A technician will ask you for the above information and if possible, help solve your problem over the phone. In the event that the unit requires factory service, the technician will issue you a Return Material Authorization Number (RMA #).
  - L. If the UPS is under warranty, the repairs will be done at no charge. If not, there will be a charge for repair.
4. Pack the UPS in its original packaging. If the original packaging is no longer available, ask the Technical Support Technician to send a new set. It is important to properly pack the UPS to avoid damage in transit. Never use Styrofoam (popcorn) beads for a packing material.
  - A. Include a letter with your name, address, day time phone number, RMA number, a copy of your original sales receipt and a brief description of the problem.
5. Mark the RMA # on the outside of all packages. The shipping department cannot accept any package without the RMA # marked on the outside.
6. Return the UPS by insured, prepaid carrier to:  
Staco Energy Products Co.  
301 Gaddis Blvd.  
Dayton, OH 45403  
ATTN: Rma # \_\_\_\_\_

## 8 SPECIFICATIONS

<b>NOTE: 230Vac Specs Shown In()</b>	SB07001	SB10001	SB20001	SB30001	S
Topology	Double Conversion On-Line				
Case Type	Tower and Rack Mount Versions Available				
Agency Approvals	UL, cUL, TUV, CE, EMC, FCC class A				
Warranty	3 year				
<b>Input (Non-Battery Operation)</b>					
Voltage Range	80-138 vac (160-274)	84-138 vac (160-274)			
Input Apparent Power Rating	700VA	1000VA	2000VA	3000VA	5
Realized Power Output Limit	500W	700W	1400W	2100W	3
Frequency Range	45 to 65 auto frequency (user denied for start o				
<b>Output (Non-Battery Operation)</b>					
Output Voltage	100, 110, 115, 120 vac (220,230,240 vac)				
Frequency	50/60 Hz +/-5 Hz				
Surge Energy Rating (one time, 10/1000 us waveform)	240 Joules	450 Joules			
<b>Output (Battery Operation)</b>					
Voltage	100, 110, 115, 120 vac (220,230,240 vac)				
Voltage Regulation	+/-2% until low battery warning				
Frequency	50 or 60 Hz +/-15 unless synchronized to				
Waveform	True Sine Wave				
Typical Transfer Time	Oms				
<b>Battery System</b>					
Battery Type	Spill proof, maintenance free, sealed lead-				
Battery system by unit	36VDC 7.2Ah	72VDC 7.2AH	96VDC 7.2Ah	240V	
Typical battery runtimes (internal battery)	10 minutes full load, 28 minutes half load				7-
External Battery Packs available	Yes, available on all models of both Tower and Rack				
<b>Typical Full load/Half Load Runtimes w/optional Batteries</b>					
Tower unit w/one external battery	54/137	33/85	44/115	38/99	5
Tower unit w/two external battery	91/228	55/141	101/237	87/209	5
Tower unit w/three external battery	155/366	101/233	159/367	138/323	1
Tower unit w/four external battery	200-471	130/299	220/505	191/541	2
Tower unit w/five external battery	266/625	175/396	271/650	245/581	2
Rack Mount unit w/one external battery	54/137	33/85	33/89	29/74	
Rack Mount unit w/two external battery	91/228	55/141	72/169	62/149	
Rack Mount unit w/three external battery	155/366	101/233	11/257	97/226	
Rack Mount unit w/four external battery	200/471	130/299	152/350	132/305	
Rack Mount unit w/five external battery	266/625	175/396	186/447	168/399	
<b>Mechanical</b>					
Tower Model Dimensions net (LxW xH)	405x145x222mm		448x216x365mm		
Tower Model Dimensions net (LxW xH)	15.94x5.71x8.74 in		17.64x8.5x14.37 in		
Tower Shipping Dimensions (LxW xH)	516x266x343mm		590x356x528mm		
Tower Shipping Dimensions (LxW xH)	20.31x10.47x13.5in		23.23x14x20.78in		
Tower Net Weight Kg (lb)	15Kg 33lb	32Kg 70.4lb	38Kg 83.6lb	95	
Tower Shipping Weight Kg (lb)	16Kg 35.2lb	34Kg 74.8lb	40Kg 88lb	105	
Rack Mount Dimensions net (LxW xH)	438x425x88mm		510x425x177mm		
Rack Mount dimensions net (LxW xH)	17.24x16.73x3.46in		20x16.73x6.97in		
Rack Mount Shipping Dims (LxW xH)	586x556x221mm		735x687x334mm		
Rack Mount Shipping Dims (LxW xH)	23.07x21.89x8.7in		28.94x27.05x13.5in		



## 9 CONFIGURABLE PARAMETERS AND SETTINGS

**(These items may require optional software or hardware)**

FUNCTION	FACTORY DEFAULT	USER CHOICES	
UPS ID	MCP-E SERIES	Up to 64 characters to define the UPS	Use th identify network
Battery installation date	Date of Manufacture	Date of Battery Replacement day/month/year (xx/xx/xxxx)	Enter t replaci
Battery life in days	Preset for 1826 days	Enter up to 5 characters	When calcula days in date an expect environ
Auto Restart: Enable/Disable	Enabled	User may Enable or Disable Auto restart	When autom operat after a and no
Set audible alarm state	Enabled	User may Enable or Disable until Low Battery Warning	Enable an aud second mode. Battery softwa or to si state, t audible reache level.
Enable or Disable all UPS function	Disabled	User is required to enable prior to operation. The UPS will not operate until enabled.	This is preven packag
Set Inverter Output Voltage	120 vac on 120 volt units. 230 vac on 230 volt units.	120 volt units: 100,110, 115,120 230 volt units: 220,230 240	Allows voltage environ will be is set v The dij panel c

## Customized Output Receptacle Panels

The Unistar Sx series UPS has a replaceable receptacle panel. The receptacle panel can be configured with multiple choices of receptacles. This will allow the user to customize the output receptacles for their specific applications. Staco Energy Products Co. will only use UL or CE approved receptacles. To customize your Staco Energy Products UPS for your specific application, contact your local distributor or contact Staco Energy Products Co. at 937-253-1191 ext. 141, 866-261-1191 or fax 937-253-1723 to find out which options are available.

The 700VA and 1000VA units may have the following optional panels:

One panel with two (2) duplex receptacles of any size.

One panel with one (1) twistlock receptacle of 20 or 30 amps.

The 2000VA and 3000VA units may have the following option panels:

One panel with two (2) duplex & one (1) twistlock receptacle of any size up to 30 amps.

Sample of Replaceable and  
Configurable panel on  
2000VA and 3000VA

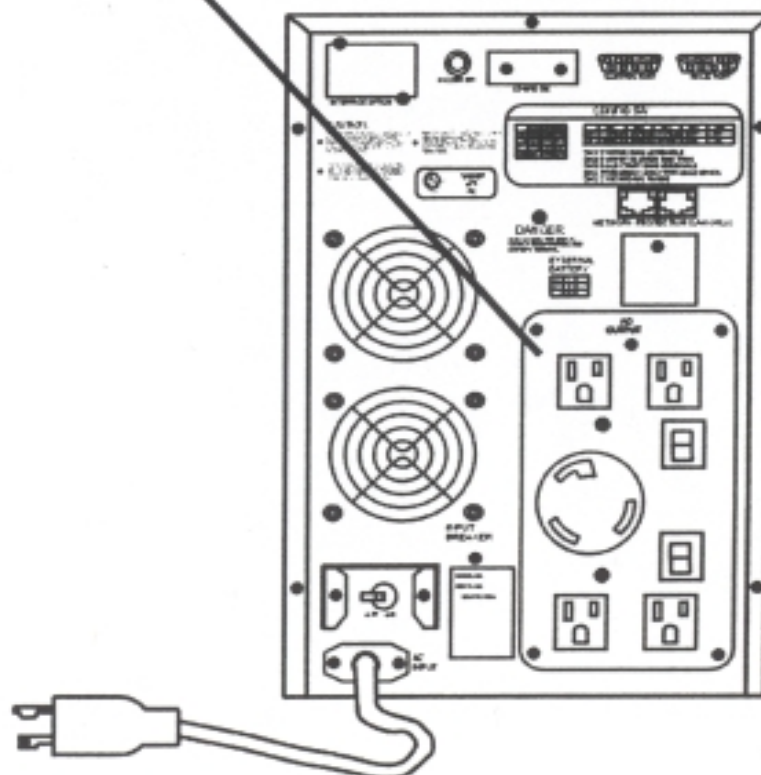

## **10 LIMITED PRODUCT WARRANTY**

STACO ENERGY PRODUCTS CO. (STACO), Dayton, Ohio, warrants this equipment, when properly applied and operated within specified conditions, to be free from defects in material and workmanship for a period of one year from the date of shipment from a STACO ENERGY PRODUCTS CO. warehouse on repair. For equipment sites within the United States, this warranty covers replacement of defective equipment at STACO's nearest service center at the sole discretion of STACO. Replacement parts and warranty labor expense will be borne by STACO. For equipment located outside the United States, the STACO warranty covers only defective parts.

This warranty shall be void if (a) the equipment is damaged by the customer, is improperly used, is subjected to an adverse operating environment, or is operated outside the limits of its electrical specifications; (b) the equipment is repaired or modified by anyone other than STACO or STACO approved personnel; (c) has been used in a manner contrary to the product's operating manual or other written instructions.

EXCEPT AS PROVIDED HEREIN, STACO MAKES NO WARRANTIES, EXPRESSED OR IMPLIED, INCLUDING WARRANTIES OF MERCHANTABILITY AND FITNESS FOR A PARTICULAR PURPOSE.

EXCEPT AS PROVIDED ABOVE, IN NO EVENT WILL STACO BE LIABLE FOR DIRECT, INDIRECT, SPECIAL, INCIDENTAL, OR CONSEQUENTIAL DAMAGES ARISING OUT OF THE USE OF THIS PRODUCT, EVEN IF ADVISED OF THE POSSIBILITY OF SUCH DAMAGE. Specifically, STACO is not liable for any costs, such as lost profits or revenue, loss of equipment, loss of use of equipment, loss of software, loss of data, cost of substitutes, claims by third parties, or otherwise. The sole and exclusive remedy for breach of any warranty, expressed or implied, concerning STACO's products and the only obligation of STACO hereunder, shall be the repair or replacement of defective equipment, components, or parts; or, at STACO's option, refund of the purchase price or substitution with an equivalent replacement product.