



UniStar II

SG0603
SG1003

SG0604
SG1004

ISE, Inc.

**10100 Royalton Rd.
Cleveland, OH 44133 USA**
Voice: (440) 237-3200 • Fax: (440) 237-1744
Internet: <http://instserv.com>

User's Manual





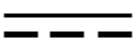

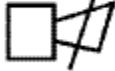

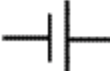

TABLE OF CONTENTS

1. INTRODUCTION	1
1.1 Explanation of symbols.....	1
1.2 System description	1
1.3 Product specification	2
Electrical specifications	2
Operating environment	2
Mechanical specification	2
1.4 Switches and displays	3
1.5 Safety	4
1.6 Communication port	6
1.7 RS232 interface	6
2. INSTALLATION AND OPERATION	7
2.1 Unpacking and inspection	7
2.2 Installation	7
2.3 Wiring description	8-10
3. TROUBLESHOOTING	11
APPLICATION NOTES	A1
1. START UP	A1
2. OUTPUT VOLTAGE SETTING	A2
3. DISPLAYS AND ALARMS	A2
1. Load level and battery capacity	A2
2. Alarm for inverter short-circuiting and output over voltage	A2
3. Alarm for bus over-voltage	A2
4. Alarm for over-temperature	A3
5. Display and alarm for overload	A3
6. Alarm for BATTERY WEAK or BATTERY BAD	A3
7. Alarm for abnormal input voltage	A4
8. Battery over-voltage alarm	A4
9. Bypass S.T.S short alarm	A4
10. Inverter S.T.S short alarm	A5
4. LIMITED PRODUCT WARRANTY	A5

1. INTRODUCTION

1.1 EXPLANATION OF SYMBOLS

Some or all of the following symbols may be used in this manual or may appear on your unit. Please take a moment to familiarize yourself with these symbols and their associated meanings.

Symbols and Their Meanings	
Symbol	Description
	Attention or consult accompanying documents
	Dangerous voltage
	On (power: connection to the mains) or output enabled
	Stand-by
	Alternating current
	Direct current
	Protective earth (ground)
	Alarm silence
	Overload
	Battery check
	Recyclable
	Do not dispose with ordinary trash

1.2 SYSTEM DESCRIPTION

The SG SERIES UPS is an advanced true on-line sine wave uninterruptible power system with automatic bypass. It provides reliable, regulated, transient-free AC power to your sensitive equipment, ranging from computers and telecommunication systems to computerized instruments. Because the UPS is in the on-line

topology type of design, conditioned power is provided continuously to its connected devices. Unlike standby UPS's, its on-line structure always regulates and filters output power when commercial power is present. During line power failure, the unit employs its internal maintenance-free battery to supply back-up power without any transfer time. In the event of an overload or inverter failure, the UPS will transfer to bypass mode as an alternate source. The UPS can transfer back to the inverter mode automatically after the overload condition has been cleared. All transfers noted above occur with zero transfer time that can ensure your equipment's continuous operation.

1.3 PRODUCT SPECIFICATIONS

ELECTRICAL & MECHANICAL SPECIFICATIONS

MODEL	Output Current	RATING	Hz	Input Voltage	Output Voltage
SG0603	28.8/27.3/26/25A	6KVA 4.2KW	50/60 Hz	170-276 VAC	208/220/230/240V
SG0604	50,25/25,28.8 25/28.8,25,25/25A	6KVA 4.2KW	50/60 Hz	170-276 VAC	120, 120/120, 208, 120/208,240,120/240V
SG1003	48.1/45.5/43.5/41.7A	10KVA 7KW	50/60 Hz	170-276 VAC	208/220/230/240V
SG1004	83.3,41.7/41.7,48 41.7/48,41.7,41.7/41.7A	10KVA 7KW	50/60 Hz	170-276 VAC	120, 120/120, 208, 120/208,240,120/240V

INPUT

Voltage: As listed
Phase: Single phase with ground
Frequency: 50/60Hz +/- 5%, auto selection
Power factor: >= 0.97

OUTPUT

Output voltage regulation: +/-3%
Power factor: 0.7 lag to unity
Frequency regulation: +/-5%, phase lock to input under normal conditions, +/-0.5% of nominal frequency, under normal operation or battery mode.
Distortion: +/-3.0% THD at full linear load, +/-7% THD at full non-linear load
Overload Capacity: >130% +/-10% for 200 ms, 105% for 10 second
Load Crest Ratio: 3:1 maximum

OPERATING ENVIRONMENT

Ambient temperature: 10 to 40 degrees Centigrade
Operation humidity: 20% to 90%, non-condensing
Altitude: less than 1500M above sea level
Storage temperature: -15 to 40° C

MODEL	MEASUREMENTS	WEIGHT
SG0603	31.5 x 10.25 x 23.25 in.	200.6(215.5)lb.
SG0604	31.5 x 10.25 x 23.25 in.	296(311.6)lb.
SG1003	38 x 13.5 x 26.5 in.	396.8(429.4)lb.
SG1004	38 x 13.5 x 26.5 in.	519.6(552.2)lb.

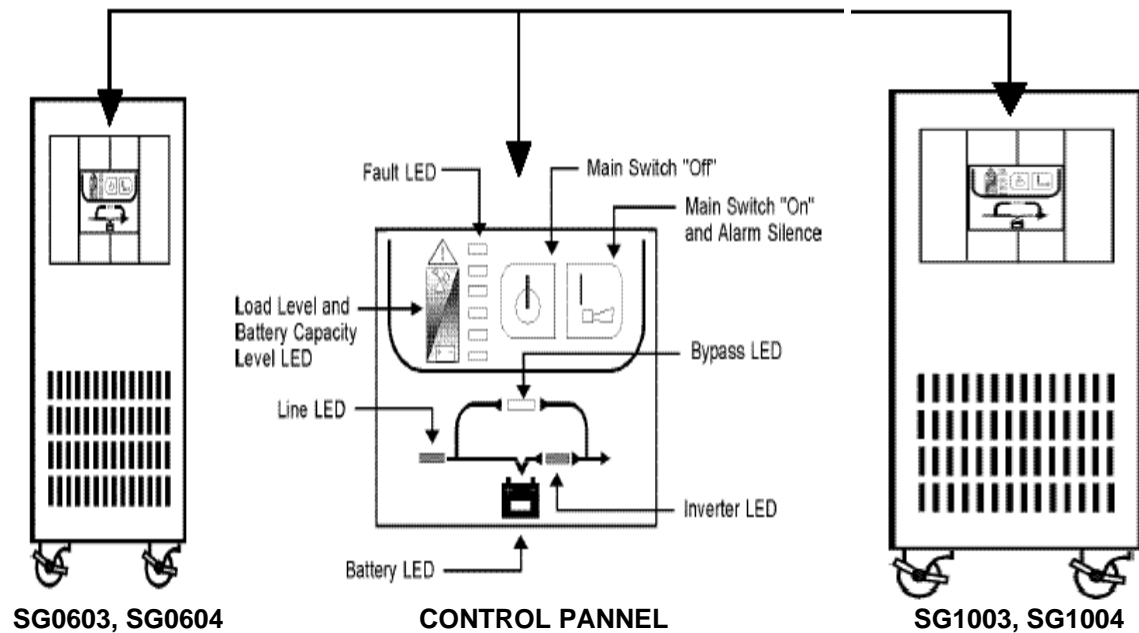

SG0603, SG0604

CONTROL PANNEL

SG1003, SG1004

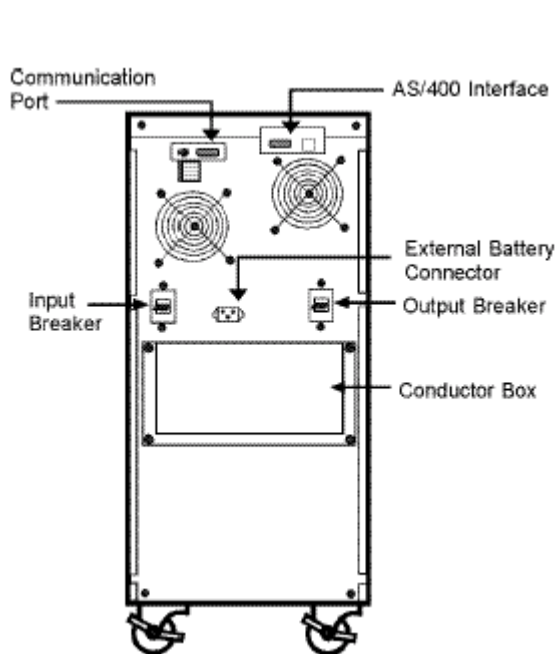

SG0603, SG0604 REAR VIEW

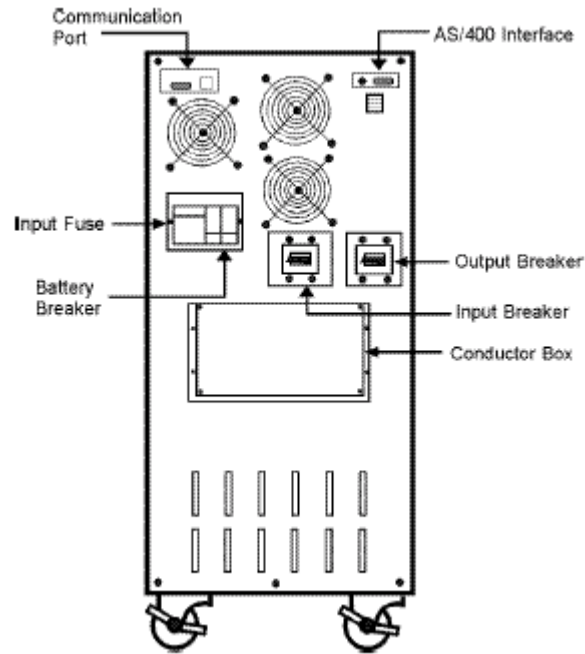

SG1003, SG1004 REAR VIEW

1.4 SWITCHES AND DISPLAYS

ON/OFF switches: Push the " ON " button until the alarm sounds to turn on UPS. Push " OFF " button until the alarm sounds to turn off UPS.

LINE LED: This light is on when the incoming AC line is normal.

BYPASS LED: This light is on when the UPS is providing power directly from the incoming AC line through the bypass route.

INVERTER LED: The light is on when the UPS is operating in " INVERTER MODE "

FAULT LED: The light is on when the UPS is in fault condition and the alarm will sound continuously.

LOAD LEVEL & BATTERY CAPACITY LEVEL: The lights form the bar graph indicate how much load or battery capacity is present in the UPS. Each LED represents a different level:

- first LED 0-35%
- second LED 35-55%
- third LED 55-75%
- fourth LED 75-95%
- fifth LED 95-110%

The bar graph shows load level during line mode. The number of " ON " LEDs increases upwards as the load increases. The UPS will go to battery mode when AC line power fails and the bar graph displays remaining battery capacity. The number of "ON" LEDs decreases upwards with the decreasing of battery capacity.

1.5 Safety

IMPORTANT SAFETY INSTRUCTIONS

This manual contains important instructions for SG SERIES that SHOULD BE FOLLOWED DURING INSTALLATION AND MAINTENANCE OF the UPS and batteries. The sound pressure level at the operator's position is equal to or less than 60dB(A).



WARNING: CHANGES OR MODIFICATIONS TO THIS UNIT NOT EXPRESSLY APPROVED BY THE PARTY RESPONSIBLE FOR COMPLIANCE COULD VOID THE USER'S AUTHORITY TO OPERATE THE EQUIPMENT.



CAUTION: TO REDUCE THE RISK OF ELECTRICAL SHOCK IN CONDITIONS WHERE LOAD EQUIPMENT GROUNDING CANNOT BE VERIFIED, DISCONNECT THE UPS FROM THE AC POWER OUTLET BEFORE INSTALLING A COMPUTER INTERFACE CABLE. RECONNECT THE POWER CORD ONLY AFTER ALL SIGNALING CONNECTIONS ARE MADE.



NOTICE: This equipment has been tested and found to comply with the limits for a Class A digital device, pursuant to part 15 of the FCC rules. These limits are designed to provide reasonable protection against harmful interference when the equipment is operated in a commercial environment. This equipment generates, uses and can radiate radio frequency energy and, if not installed and used in accordance with the instruction manual, may cause interference to radio communications. Operation of this equipment in a residential area is likely to cause harmful interference, in which case the user will be required to correct the interference at his own expense. This digital apparatus does not exceed the Class A limits for radio noise emissions from digital apparatus set out in the Radio interference regulations of the Canadian Department of Communications.

Le présent appareil numérique n'émet pas de bruits radioélectroniques dépassant les limites applicables aux appareils numériques de la Class A prescrites dans le Règlement sur le brouillage radioélectronique édicté par le ministère des Communications du Canada.

STACO ENERGY PRODUCTS CO. LIFE SUPPORT POLICY

As a general policy, STACO ENERGY PRODUCTS CO. (STACO ENERGY PRODUCTS CO.) does not recommend the use of any of its products in life support applications where failure or malfunction of the STACO ENERGY PRODUCTS CO. product can be reasonably expected to cause failure of the life support device or to significantly affect its safety or effectiveness. STACO ENERGY PRODUCTS CO. does not recommend the use of any of its products in direct patient care. STACO ENERGY PRODUCTS CO. will not knowingly sell its products for use in such applications unless it receives in writing assurances satisfactory to STACO ENERGY PRODUCTS CO. that (a) the risks of injury or damage have been minimized, (b) the customer assumes all such risks, and (c) the liability of STACO ENERGY PRODUCTS CO. is adequately protected under the circumstances.

Examples of devices considered to be life support devices are neonatal oxygen analyzers, nerve stimulators (whether used for anesthesia, pain relief, or other purposes), auto transfusion devices, blood pumps, defibrillators, arrhythmia detectors and alarms, pacemakers, hemodialysis systems, peritoneal dialysis systems, neonatal ventilator incubators, ventilators for both adults and infants, anesthesia ventilators, and infusion pumps as well as any other devices designated as "critical" by the United States FDA.

Hospital grade wiring devices and leakage current may be ordered as options on many STACO ENERGY PRODUCTS CO. UPS systems.

STACO ENERGY PRODUCTS CO. does not claim that units with this modification are certified or listed as Hospital Grade by STACO ENERGY PRODUCTS CO. or any other organization. Therefore, these units do not meet the requirements for use in direct patient care.

CAUTIONS:

The UPS contains voltages which are potentially hazardous. All repairs should be performed by qualified service personnel. The UPS has its own internal energy source (battery). The output may be 'hot' even when the UPS is not connected to the AC supply.

* The voltage internal batteries create is: 240 VOLTS

- ⚠ For the safety of the UPS, do not connect an imbalanced load.
- ⚠ An insulated grounding conductor should be identical in size, thickness, and insulation material to the grounded and ungrounded branch-circuit supply conductors. The wire, which should be green or green with one or more yellow stripes, is to be installed as part of the branch circuit that supplies the unit. Grounding conductor must be minimum #8 AWG wire.
- ⚠ The grounding conductor described in the above item shall be grounded to the earth end of the protected equipment.
- ⚠ These sealed lead-acid batteries have pressure operated vents.
- ⚠ Servicing of batteries should be performed or supervised by personnel knowledgeable of batteries and the required precautions. Keep unauthorized personnel away from batteries.
- ⚠ When replacing batteries, replace with the same number of the following type: Matsushita (Panasonic) Electric Works Type LCR12V7.2P (12V 7.2 AH) or CSB Battery Co., Ltd Type GP1270F2 (12V 7.0AH).
- ⚠ CAUTION - Do not dispose of any battery in a fire as it may explode. Lead-acid batteries generate hydrogen gas. Do not smoke when near batteries.
- ⚠ CAUTION - Do not open or mutilate the battery or batteries. The electrolyte is a dilute sulfuric acid. Released electrolyte is harmful to the skin and eyes. It may be toxic. It is electrically conductive and corrosive.
- ⚠ CAUTION - A battery can present a risk of electric shock and high short circuit current. The following precautions should be observed when working on batteries:
 - ⚠ Remove watches, rings and/or other metal objects.
 - ⚠ Use tools with insulated handles.
 - ⚠ Wear rubber gloves and boots. Wear full eye protection and protective clothing.
 - ⚠ If electrolyte contacts the skin, wash it off immediately with water. If electrolyte contacts the eyes, flush thoroughly and immediately with water. Seek medical attention.
 - ⚠ Spilled electrolyte should be washed down with a suitable acid neutralizing agent. Use approximately 1 pound of bicarbonate soda to approximately one gallon of water. The solution should be added until reaction has ceased. The resulting liquid should be flushed with water.
 - ⚠ Do not lay tools or metal parts on top of batteries.
 - ⚠ Discharge static electricity from body before touching batteries by first touching a grounded metal surface. ⚠ Disconnect charging source prior to connecting or disconnecting battery terminals.
 - ⚠ Determine if the battery is inadvertently grounded. If inadvertently grounded, remove source of ground. Contact with any part of a grounded battery can result in electric shock. The likelihood of such shock will be reduced if such grounds are removed during installation and maintenance.

The safe and continuous operation of the UPS depends partially on the care taken by the user. Please note the following precautions:

- ⚠ Do not disassemble the UPS.
- ⚠ Do not place the UPS near water or in an environment of excessive humidity.
- ⚠ Do not allow liquid or any foreign object to get inside the UPS.
- ⚠ Do not block air vents in the front of the UPS or air exhaust holes in the back.
- ⚠ Do not place the UPS under direct sunshine or close to heat-emitting source.
- ⚠ For prevention of UPS failure, please do not change the voltage setting switches.

HAZARDOUS VOLTAGE

- ⚠ Battery circuit is not isolated from the input voltage. There may be a hazardous voltage between battery terminals and ground. **Check it before touching!**
- ⚠ Even after disconnection from the mains input voltage, components inside the UPS are still connected to the battery and area hazardous potential. Disconnect the battery supply circuit before carrying out servicing or maintenance work.

1.6 COMMUNICATION PORT

The UPS provides an RS232 serial port to communicate with a host computer. The host computer can monitor the UPS through this RS232 communication port.

The data format of RS232 is as follows:

Baud Rate : 2400 bps

Data Length : 8 bits

Ending Code : 1 bit

Parity Bit : none

1.7 RS-232 IINTERFACE

The following is the pin assignment and description of DB-9 connector.

Pin #	Description	I/O
2	RS232 Rx	input
3	RS232 Tx	output
5	Ground	input

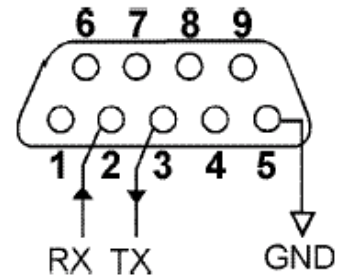

2. INSTALLATION AND OPERATION

2.1 UNPACKING AND INSPECTION

Examine packing carton for damage. Notify the carrier immediately if damage is present. Retain the packing carton for future use.

2.2 INSTALLATION

The UPS should be installed by professional service personnel. To prevent an overbalance of this equipment, the supporter must be mounted at the bottom of the enclosure. Please install the supporters to the UPS at the bottom of both sides with six screws (see figure)

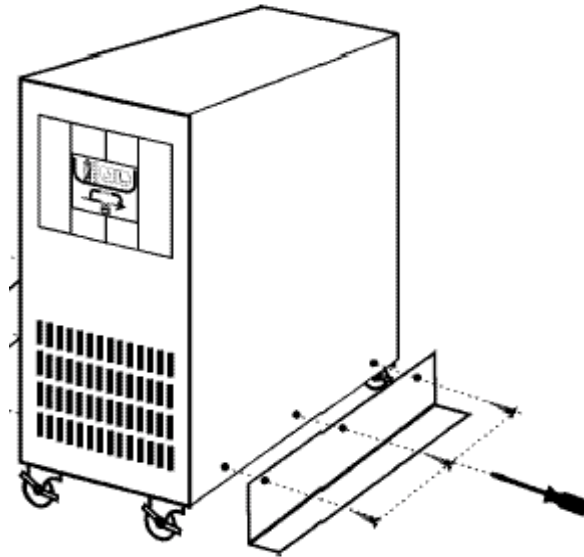

With the installation of the supporters, tipping of the UPS should be prevented. The socket-outlet should be near the equipment and easily accessible.

Notes:

- ⚠ The UPS should be placed in a flat location with a distance of at least 10cm from the wall to the vent. In addition, keep the UPS away from heat-emitting sources, direct sunshine, rain, or erosive gas.
- ⚠ Do not place any objects on the top of the UPS.
- ⚠ The function of an alarm silence is available. Users can silence the alarm by pressing the "ON" button. Press it again will re-activate the alarm (except when the battery is in low-battery mode.)
- ⚠ Press the button and hold it for more than 0.5 second to ensure safe operation.

2.3 WIRING DESCRIPTION

The wiring method is described in the following figure:

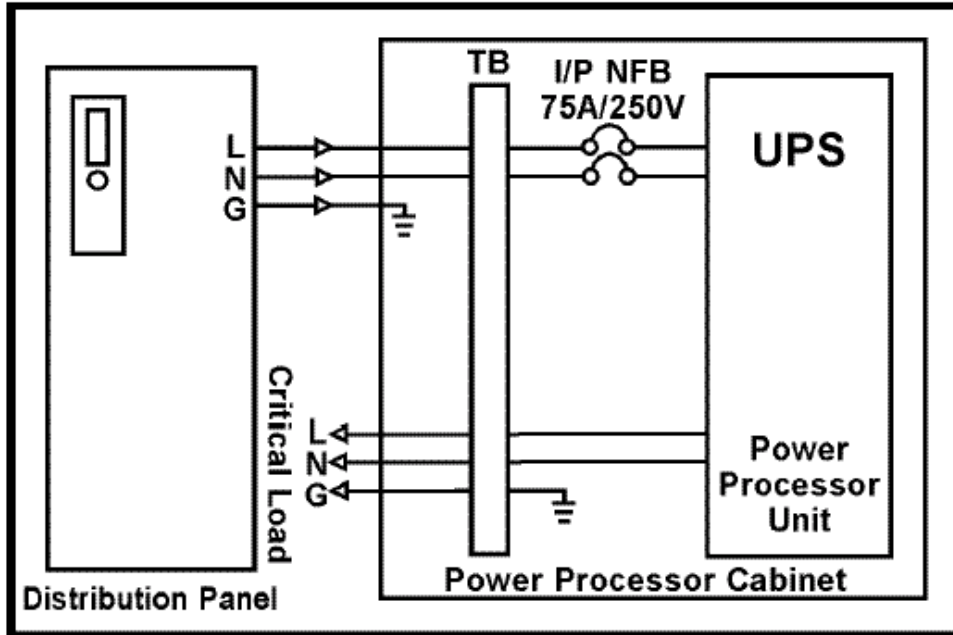

REAR VIEW

Wiring Instructions:

1. Utility panel circuit breaker required is 30A or larger
2. Utility wire gauge must be 8 gauge or larger.
3. Connect utility per drawing.
4. Connect output load connections and jumper wires for correct voltages per drawings(not used on units without an isolation transformer; i.e. SG0603 and SG1003).
5. Use proper size AWG wires for all connections.

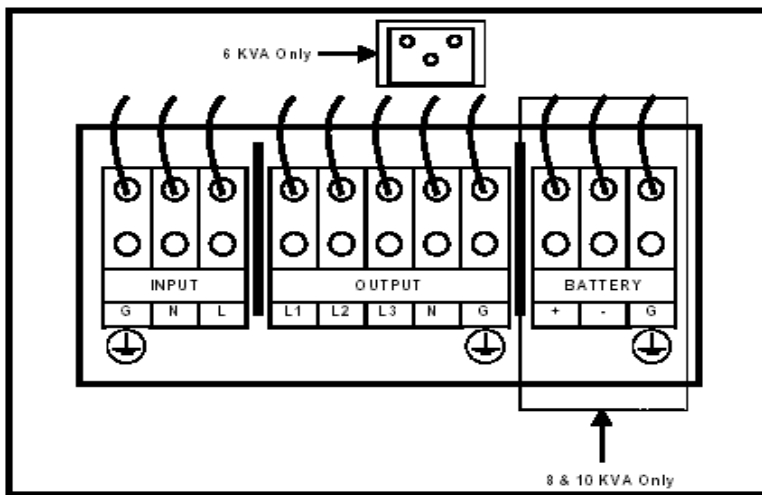

NOTE: STACO ENERGY PRODUCTS DOES CO. NOT PROVIDE AC OUTPUT OVERCURRENT PROTECTION. OUTPUT OVERCURRENT PROTECTION IS TO BE PROVIDED BY THE USER.

OUTPUT VOLTAGE CONFIGURATIONS

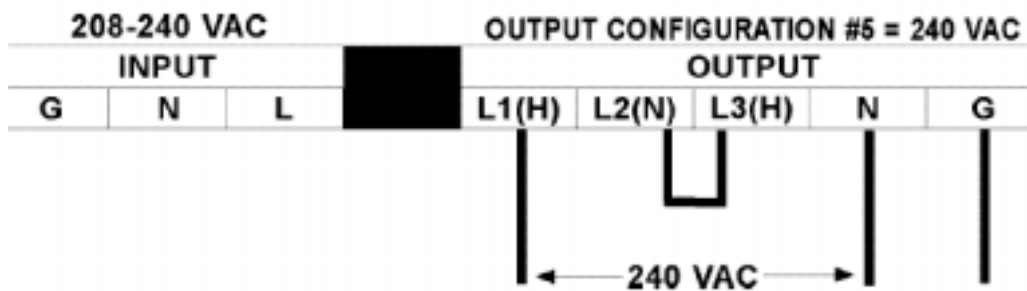
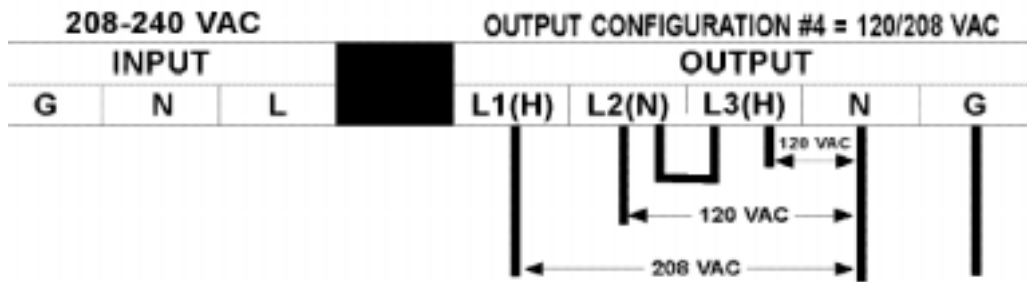
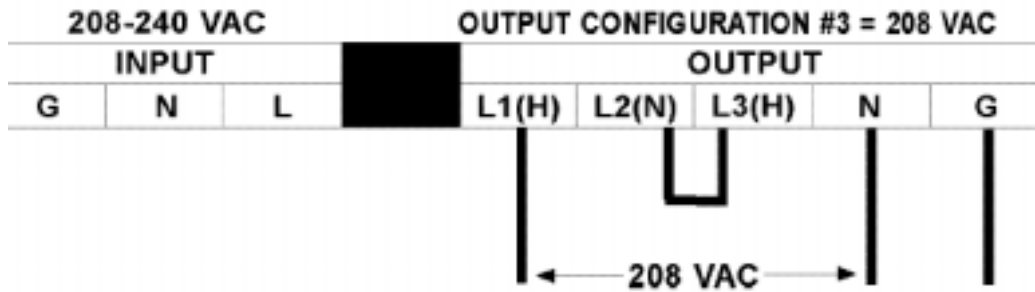
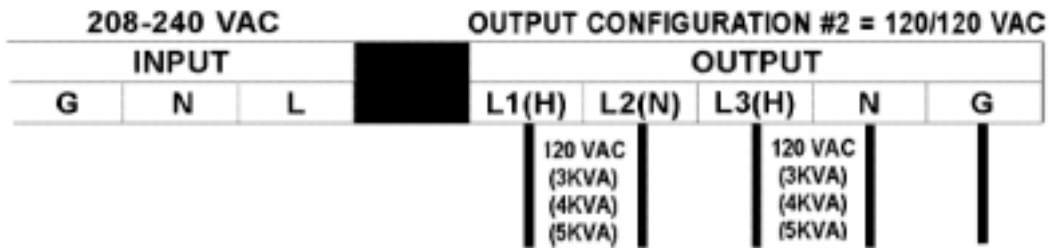
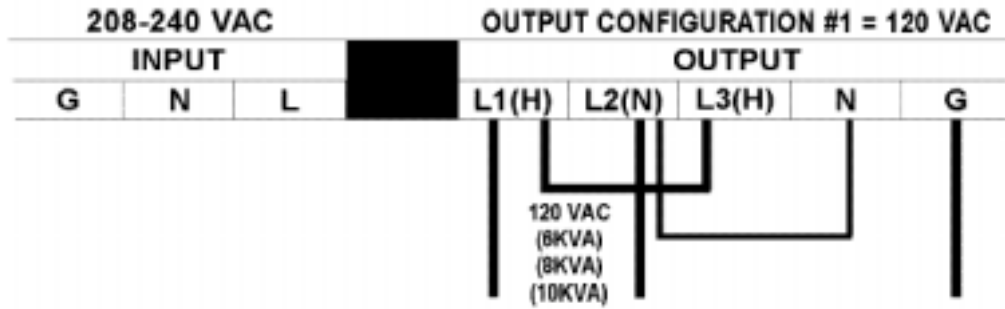

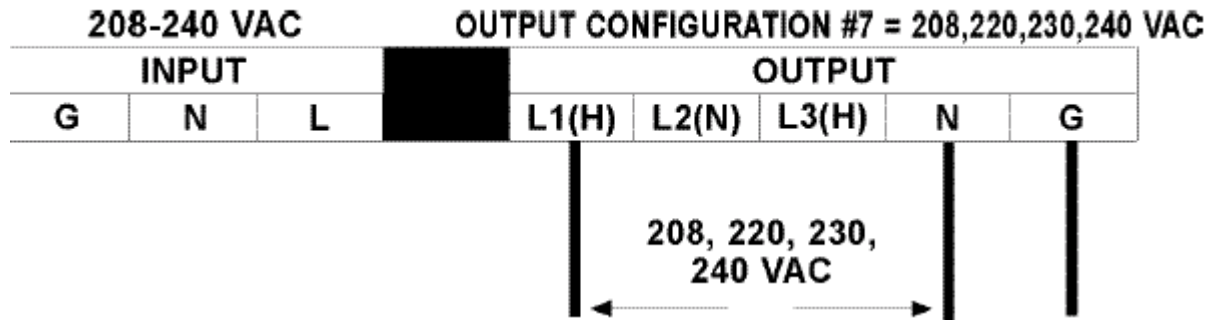
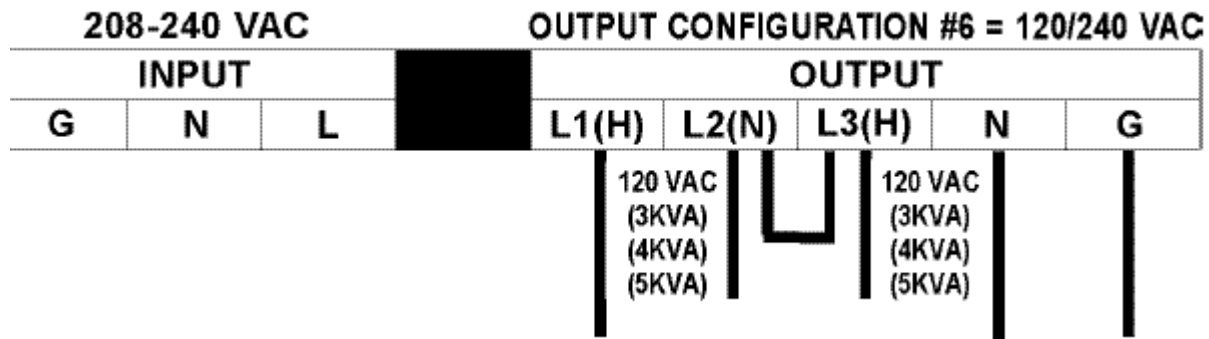

- ⚠ Output configurations #1, #2, #3, #4, #5, and #6 are only available on units with an isolation transformer
- ⚠ Output configuration #7 is only used on units without an isolation transformer
- ⚠ When using the isolation transformer, ensure that the load is balanced.
- ⚠ When using #6 AWG wire 2 in. are required for wire bending space opposite the terminals. 1 1/2 in. for #8 AWG. 3 in. for #3 AWG and #4 AWG. 3 1/2 in. for #2 AWG.
- ⚠ For 6KVA output configuration #1, use #6 AWG, 75°C copper wire. For configurations #2, #3, #4, #5, #6, and #7 use #6 AWG, 75°C copper wire
- For 10KVA output voltage configuration #1, use #2 AWG, 115°C copper wire. For configurations #2, #3, #4, #5, #6, and #7 use #6 AWG, 75°C copper wire.

Tightening torque for pressure wire connectors having screws

		Tightening torque, pound-inches (N-m)			
		Slotted head No. 10 (4.7mm) and Larger		Hexagonal head - external drive socket wrench	
Size of wire that is to be used for connection of the unit		Slot width - 0.047 in. (1.2mm) or less, and slot length - 1/4 inch (6.4mm) or less	Slot width - over 0.047 in. (1.2mm) and slot length - 1/4 inch (6.4mm)	Split-bolt connectors	Other connection
AWG/kcmil	mm ²				
8	8.4	25 (2.8)	25 (2.8)	80 (9.0)	75 (8.5)
6-4	13.3-21.2	35 (4.0)	45 (5.1)	165 (18.6)	110 (12.4)
3	26.7	35 (4.0)	50 (5.6)	275 (31.1)	150 (16.9)
2	33.6	40 (4.5)	50 (5.6)	275 (31.1)	150 (16.9)

Size of grounding electrode conductors (cooper wire)

Maximum current rating (amperes)	Maximum size of equipment grounding or bonding conductor AWG	Minimum size of grounding electrode conductor AWG	Maximum size of equipment grounding or bonding conductor AWG
60	10	8	8
90	8	8	8
100	8	6	6
150	6	6	6

3. TROUBLESHOOTING

The **TROUBLESHOOTING CHART** covers most of the difficulties you may encounter under normal working conditions.

TROUBLESHOOTING CHART		
Problem	Possible cause	Problem
"FAULT" LED lights, alarm beeps continuously	UPS failure	Call for service
Backup time is less than the rating	Battery is not fully charged, dead battery, charger failure	Recharge battery for at least 6 hours, retest the backup time. If problem remains, call for service
Buzzer beeps twice per second	Overloaded	Remove the least critical load

OBTAINING SERVICE

If the UPS requires service;

1. Use the **TROUBLESHOOTING CHART** to eliminate obvious causes.
2. Verify that no circuit breakers are tripped. A tripped circuit breaker is the most common problem.
3. Call or FAX ISE, Inc. Technical Support at the following numbers: Voice phone (440) 237-3200, FAX line (440) 237-1744, e-mail: <mailto:support@instserv.com>. Please have the following information available BEFORE calling technical support.
 - A. Your Name and address.
 - B. Where and when the unit was purchased.
 - C. All of the model information on the rear of your UPS.
 - D. Any information on the failure, including LEDs that may be illuminated.
 - E. A description of the protected equipment, including model numbers if possible.
4. A technician will ask you for the above information and, if possible, help solve your problem over the phone. In the event that the unit requires factory service, the technician will issue you a Return Material Authorization Number (RMA #). If the UPS is under warranty, the repairs will be done at no charge. If not, there will be a charge for repair.
5. Pack the UPS in its original packaging. If the original packaging is no longer available, ask the technical support technician about obtaining a new set. It is important to pack the UPS properly in order to avoid damage in transit. Never use Styrofoam beads for a packing material. Include a letter with your name, address, day time phone number, RMA number, a copy of your original sales receipt, and a brief description of the trouble.
6. **Mark the RMA # on the outside of all packages. The factory cannot accept any package without the RMA # marked on the outside.**
7. Return the UPS by insured, prepaid carrier to the shipping address provided with the RMA:

APPLICATION NOTES

1. START-UP

1. Turn on Input breaker on the rear panel after checking the power wiring. The cooling fans should be rotating and the control panel should show the display as below.

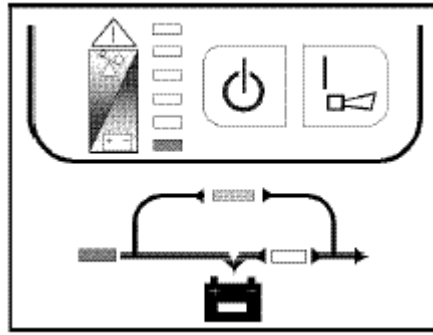

Fig 1.1-1 Bypass Mode (Load LED display depends of load level)

2. Then press the “|” button. After 10 seconds, the control panel will become what is shown in Fig. 1.2-1.
3. Turn on the output breaker located on the rear panel to provide power to the load.

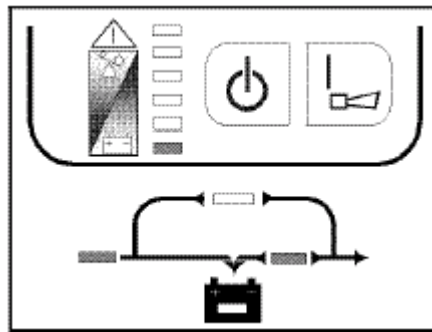

Fig 1.2-1 Inverter Mode

4. The UPS should be successfully started.
5. If the UPS is in normal operation, the user can run a battery-mode test by pushing the “ON” button. The four LED’s on the lower half of the control panel (i.e. line, bypass, battery, inverter) will flash.
6. To turn off the UPS, push the “OFF” button, then turn off the line breaker.

2. OUTPUT VOLTAGE SETTING

Four voltage options are available (208V, 220V, 230V, 240V). Users can set the desired voltage through DIP SWITCHES located on the rear panel. The output voltage can be switched according to the instructions below.

1. Press the “OFF” button to turn off the UPS.
2. Switch the output breaker to the OFF position.
3. Turn off Input breaker.
4. Wait until the fans stop turning, then switch the DIP SWITCHES to the desired voltage position. Table 2-1, also printed under DIP SWITCHES, shows these four positions and their corresponding voltage levels.
5. After setting the switches, turn on the Input breaker, press the “|” button and then turn on the output breaker.

NOTE: On units with an isolation transformer, the secondary voltage will be 1/2 of the DIP SWITCH setting. The voltage setting has been successfully changed when the UPS switches to INVERTER mode.

↑	↓	208
↓	↓	220
↑	↑	230
↓	↑	240

Table 2-1

3. DISPLAYS AND ALARMS

1. Load level and battery capacity is represented by 5 LEDs on the upper half of control panel (the 6th LED means FAULT).

(A). When the UPS is in on-line mode, the 5 LEDs represent load level. They denote 0%~35%, 35%~55%, 55%~75%, 75%~95% and 95%~105% (from bottom to top) of maximum load capacity. If the load amount reaches 105%~130%, the UPS is in overload such that the 6 LEDs would illuminate simultaneously. The UPS will then switch to BYPASS mode 10 seconds later. In addition, if the load is over 130%, the UPS will switch to BYPASS immediately.

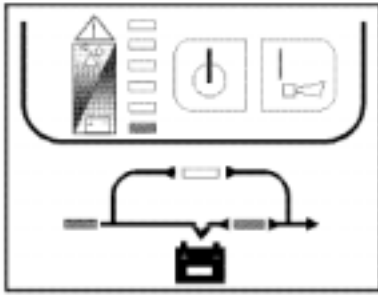

Fig 3.1-1 Inverter Mode

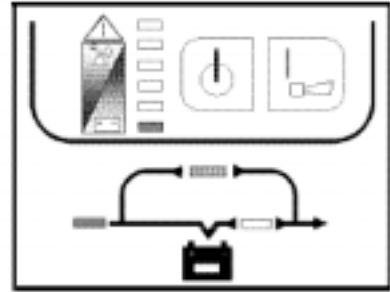

Fig 3.1-2 Bypass Mode

(B). During an AC line power failure, these 5 LEDs represent the remaining battery capacity. The LED's will extinguish by the sequence from bottom to top as the battery voltage level decreases.

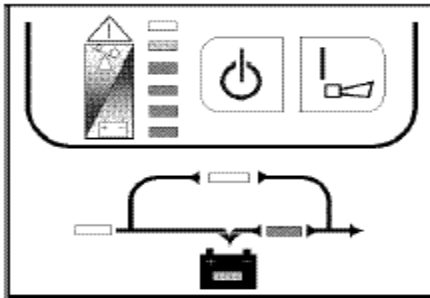

Fig 3.1-3 Battery Mode

2. An alarm will sound continuously during inverter short-circuiting or an output over voltage condition.

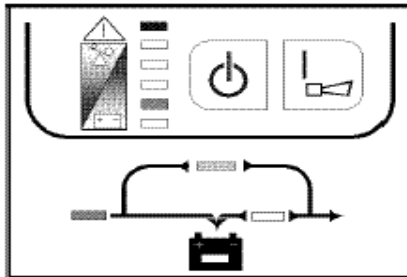

Fig 3.2-1 Line Mode

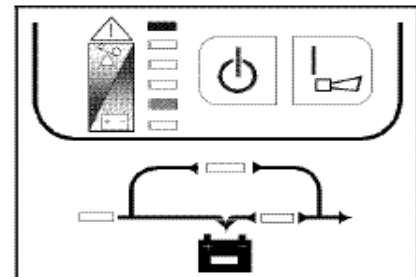

Fig 3.2-2 Battery Mode

3. An alarm will sound continuously during a bus over voltage condition.

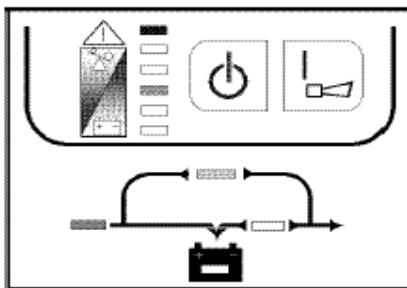

Fig 3.3-1 Line Mode

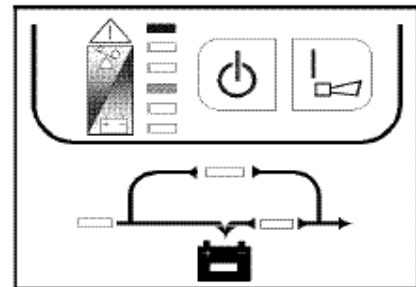

Fig 3.3-2 Battery Mode

Page A2

4. An alarm sounds continuously during an over-temperature condition.

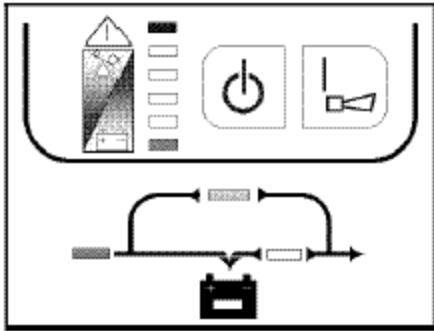

Fig 3.4-1 Line Mode

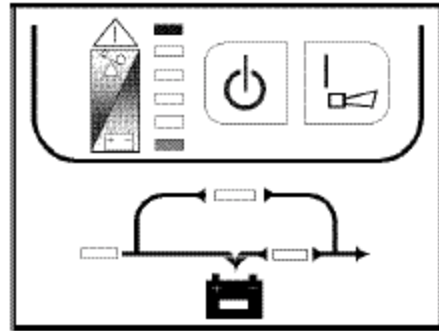

Fig 3.4-2 Battery Mode

5. Display and alarm for overload

The alarm will sound once every 0.5 seconds during an overload condition. While in inverter mode, the alarm can be silenced by pressing the "OFF" button. In the Battery Test mode, the UPS will go to BYPASS immediately and the alarm will sound continuously.

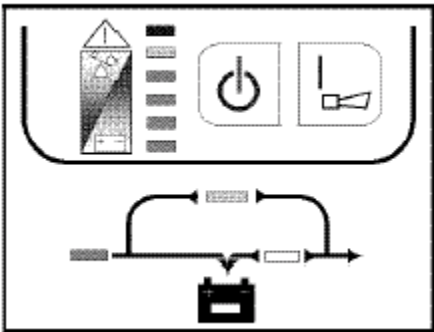

Fig 3.5-1 Bypass Mode

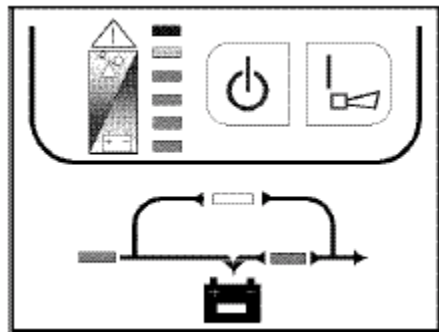

Fig 3.5-2 Inverter Mode

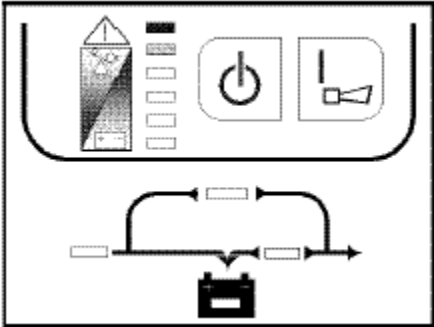

Fig 3.5-3 Battery Mode Overload

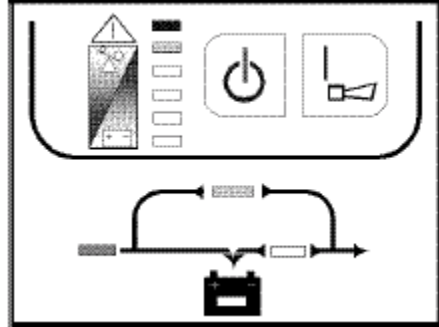

Fig 3.5-4 Battery Test

6. Alarm for WEAK BATTERY or BAD BATTERY

(A) WEAK BATTERY - when the battery voltage goes below 215V, the Battery LED will flash.

(B) BAD BATTERY - If the battery voltage falls below 140V, an alarm will sound continuously. The Battery LED will flash and the FAULT LED will illuminate and the UPS will stay in INVERTER mode. If AC line power fails during this condition, the UPS will shut down.

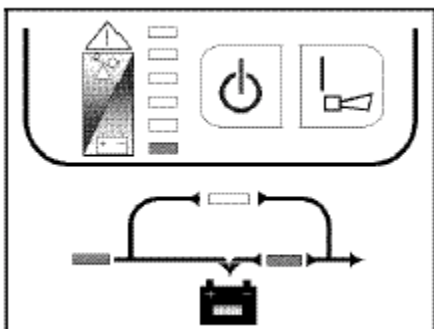

Fig 3.6-1 Weak Battery

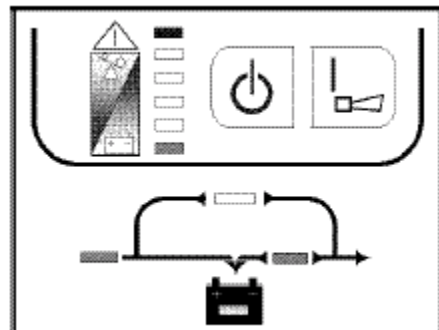

Fig 3.6-2 Bad Battery

7. Alarm for abnormal input voltage

A) During Start-up, the Line LED will flash if the input voltage drops below 185V or above 261V. Pressing the “I” button will not switch the UPS from Bypass Mode to Inverter Mode.

(B) During operation, the UPS will switch from Inverter Mode to Battery Mode if the input voltage drops below 170V or above 276V.

(C) In Battery Mode, the UPS does not change mode even if the line power recovers when voltage is below 170V or above 276V. If voltage is between 185V and 261V, the UPS will switch back to Line Mode.

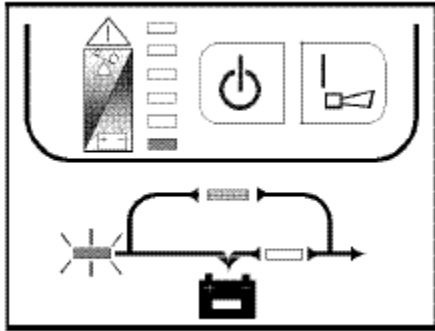

Fig. 3.7-1 Bypass Mode

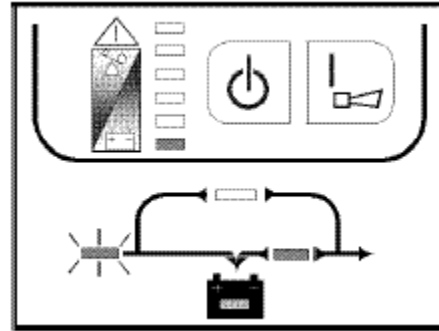

Fig. 3.7-2 Battery Mode

8. Battery Mode over-voltage alarm

When the battery voltage exceeds 300V, the alarm will sound continuously and show the display below:

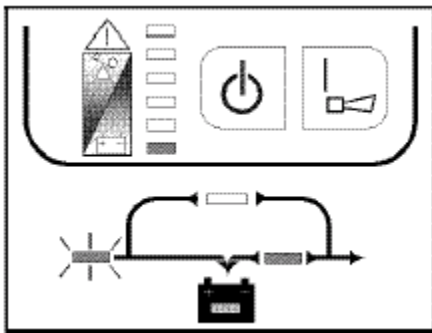

Fig. 3.8-1 Bypass Mode

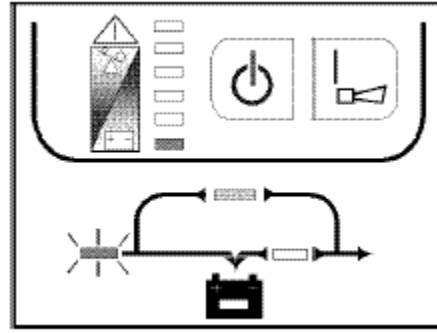

Fig. 3.8-2 Inverter Mode

NOTE: In Battery Mode, the batteries are discharging, hence no alarm sounds.

9. Bypass STS short alarm

The system will detect if the bypass STS gets shorted when the line breaker is turned on. If the STS short is detected, the display shows as below and the alarm sounds continuously.

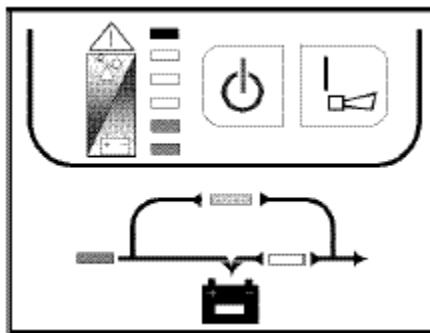

Fig 3.9 Bypass Short Alarm

10. Inverter STS short alarm

The system will detect if the inverter STS is shorted when the "ON" button on the control panel is pressed. If the STS short is detected, the display shows as below and the alarm sounds continuously.

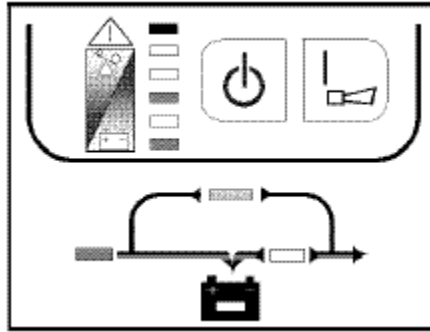

Fig. 10.1 Inverter STS short alarm

LIMITED PRODUCT WARRANTY

STACO ENERGY PRODUCTS CO. (STACO), Dayton, Ohio, warrants this equipment, when properly applied and operated within specified conditions, to be free from defects in material and workmanship for a period of one year from the date of shipment from the STACO warehouse on repair. For equipment sites within the United States, this warranty covers replacement of defective equipment at STACO's nearest service center at the sole discretion of STACO. Replacement parts and warranty labor expense will be borne by STACO. **For equipment located outside the United States, the STACO warranty covers only defective parts.**

This warranty shall be void if (a) the equipment is damaged by the customer, is improperly used, is subjected to an adverse operating environment, or is operated outside the limits of its electrical specifications; (b) the equipment is repaired or modified by anyone other than STACO or STACO approved personnel; (c) has been used in a manner contrary to the product's operating manual or other written instructions.

EXCEPT AS PROVIDED HEREIN, STACO MAKES NO WARRANTIES, EXPRESSED OR IMPLIED, INCLUDING WARRANTIES OF MERCHANTABILITY AND FITNESS FOR A PARTICULAR PURPOSE.

EXCEPT AS PROVIDED ABOVE, IN NO EVENT WILL STACO BE LIABLE FOR DIRECT, INDIRECT, SPECIAL INCIDENTAL, OR CONSEQUENTIAL DAMAGES ARISING OUT OF THE USE OF THIS PRODUCT, EVEN IF ADVISED OF THE POSSIBILITY OF SUCH DAMAGE. Specifically, STACO is not liable for any costs, such as lost profits or revenue, loss of equipment, loss of use of equipment, loss of software, loss of data, costs of substitutes, claims by third parties, or otherwise. The sole and exclusive remedy for breach of any warranty, expressed or implied, concerning STACO's products and the only obligation of STACO hereunder, shall be the repair or replacement of defective equipment, components, or parts; or, at STACO's option, refund of the purchase price or substitution with an equivalent replacement product.