

**SCR POWER CONTROLS
3PCI SERIES
25 A THROUGH 1200 A
OPERATION MANUAL**

**Manual Number: 19000325
Version 1.1
July 2003**

Caution - Electrical Hazard! The use of an appropriate single-phase or three-phase fused disconnect or circuit breaker with this power controller is required to ensure the safety of operating personnel.

Hazardous Voltages exist at the power controller heat sinks and at the load, at all times, when input voltage is connected. This condition exists even when the power controller is set to deliver zero output.

Warning! The fused disconnect or circuit breaker must be "open" or "off" to perform maintenance of any kind, including at the Load.

ORIGINAL EQUIPMENT MANUFACTURERS

Please Note

If this manual is not supplied to the end user, a warning statement identical to the above statement should be prominently displayed in the installation and operation instructions provided to the end user.

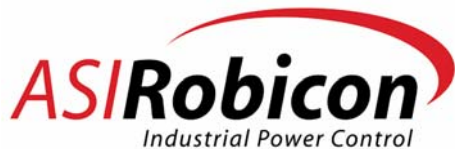

This manual applies to all 3PCI Series power controllers (25 A through 1200 A) manufactured by ASI Robicon and replaces manual 19000325 in its entirety.

Edited by: Nancy Sutherland
Copyright 1999 - ROBICON

SCR Power Controls 3PCI Operation Manual (p/n 19000325)
Revision History:

Version 1.0	May 2003
Version 1.1	July 2003

© 1999 by ROBICON. No portion of this document may be reproduced either mechanically or electronically without the prior consent of ROBICON.

TABLE OF CONTENTS

CHAPTER 1: INTRODUCTION

1.1. Overview	1-1
1.2. Operation	1-2
1.3. Three-phase Overcurrent (OC) Trip Feature	1-2
1.4. Three-phase Current Limit (CL) Feature	1-3
1.5. Options	1-3
1.5.1. Three-phase Current Regulation (CR) Option	1-3
1.5.2. Current Imbalance Detection (CID) Option	1-3
1.5.3. Lug Kit (LK) Option	1-3
1.5.4. Extended Ramp (ER) and Fast Ramp (FR) Options	1-3
1.6. Technical Specifications	1-3

CHAPTER 2: INSTALLATION

2.1. Mounting the 3PCI	2-1
2.2. Fan Wiring (Models Rated at 90 A and Higher)	2-1
2.3. Wiring Overtemperature Contacts	2-1
2.4. Input/Output Wiring	2-1
2.5. Internal 3PCI Connections	2-4

CHAPTER 3: OPERATION

3.1. Introduction	3-1
3.2. Internal Manual Control of Power Output	3-1
3.3. Temperature Controller	3-2
3.4. Remote Manual Control (Only) with a Potentiometer	3-2
3.5. Auto/Manual Control with a Controller and Remote Potentiometer	3-3
3.6. On/Off Control	3-3
3.6.1. Output Enabled by Contact Closure	3-3
3.6.2. Output Disabled by Contact Closure	3-4
3.7. Controlling Several 3PCIs in Parallel with One Controller	3-4

CHAPTER 4: OPTIONS SETUP

4.1. Introduction	4-1
4.2. Option CL (3-phase Current Limit)	4-1
4.3. Option CID (Current Imbalance Detector)	4-1
4.4. Reset Push-button (User Supplied)	4-1
4.5. Adjusting the Overcurrent (OC) Feature	4-1

CHAPTER 5: TROUBLESHOOTING

5.1. Customer Service Program	5-1
5.2. Troubleshooting Typical Symptoms	5-1
5.3. Static Precautions When Servicing	5-1
5.4. Environmental Problems	5-4
5.4.1. Inadequate Cooling	5-4
5.4.2. Contamination	5-4
5.4.3. High Ambient Temperature	5-4
5.4.4. Excessive Vibration	5-5
5.5. Input Power and Load Connections	5-5
5.6. Correcting Specific 3PCI Problems	5-5
5.7. Replacement Fuses	5-6
5.8. Torque Specifications	5-6

CHAPTER 6: SERVICE

6.1. How to Contact ROBICON6-1
6.2. Spare Parts.....6-1
6.3. Drawing List.....6-4

ADDENDUMA-1

INDEX

SUPPLEMENTS

DRAWINGS

▽▽▽

LIST OF FIGURES**CHAPTER 1: INTRODUCTION**

Figure 1-1.	Typical 3PCI Power Controller	1-1
Figure 1-2.	Front, Cutaway and Side Views of a Typical 25A to 225A 3PCI Controller.....	1-2

CHAPTER 2: INSTALLATION

Figure 2-1.	Typical 3PCI Line and Load Connections	2-2
Figure 2-2.	Input and Output Connections Overview for the 3PCI.....	2-3

CHAPTER 3: OPERATION

Figure 3-1.	Automatic Controller Input Connections	3-2
Figure 3-2.	Remote Control with a Potentiometer	3-2
Figure 3-3.	Auto/Manual Control with Controller and Remote Potentiometer	3-3
Figure 3-4.	On/Off Control with Output Enabled by Contact Closure.....	3-3
Figure 3-5.	On/Off Control with Output Disabled by Contact Closure.....	3-4
Figure 3-6.	Controlling Several 3PCIs Connected in Parallel.....	3-4

LIST OF TABLES**CHAPTER 1: INTRODUCTION**

Table 1-1.	General Technical Specifications.....	1-4
Table 1-2.	3PCI Model Number Code Descriptions	1-5

CHAPTER 2: INSTALLATION

Table 2-1.	Wire Size Information.....	2-2
Table 2-2.	Terminal Block Specifications	2-3

CHAPTER 3: OPERATION

Table 3-1.	Matching SCR Power Control to an External Controller Signal.....	3-1
------------	--	-----

CHAPTER 5: TROUBLESHOOTING

Table 5-1.	3PCI Troubleshooting Symptoms and Solutions	5-5
Table 5-2.	Fuse Specifications	5-6
Table 5-3.	Torque Specifications Based on Conductor Sizes.....	5-7
Table 5-4.	Torque Specifications Based on Socket Sizes (For All Conductor Sizes).....	5-7

CHAPTER 6: SERVICE

Table 6-1.	Spare Parts	6-1
Table 6-2.	Drawing List.....	6-4

▽ ▽ ▽

CHAPTER 1: INTRODUCTION

In This Section:

- Overview 1-1
- Operation 1-2
- Three-phase Overcurrent (OC) Trip Feature..... 1-2
- Three-phase Current Limit (CL) Feature 1-3
- Options..... 1-3
- Technical Specifications 1-3

1.1. Overview

This manual covers the 3PCI (3-phase, cosine intercept) series of power controllers by ASI Robicon. The 3PCI models are rated from 25 A through 1200 A (as specified in Table 1-2 on page 1-5). Series 3PCI power controllers provide control of three-phase power to resistive and inductive loads. The 3PCI utilizes infinite firing angle resolution for precise SCR control. A typical 3PCI is illustrated in Figure 1-1.

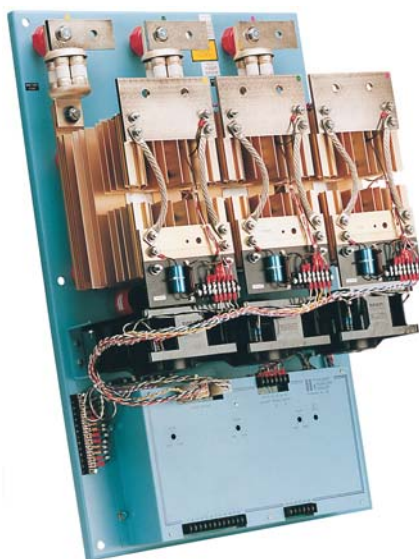

Figure 1-1. Typical 3PCI Power Controller

The 3PCI is a three-phase, phase-fired power controller, and can operate with a wide variety of input signals and line voltages. The 3PCI's output voltage is proportional to the control input signal, with the output voltage regulated to $\pm 0.5\%$ with a $\pm 10\%$ line voltage change. The 3PCI features cosine intercept, hard-gate firing which provides high immunity to possible SCR firing disturbances. Other features include the following:

- input isolation from ground (galvanic)
- soft-start capability
- automatic restart circuitry
- 50/60 Hz operation without any required changes.

Terminals are provided to permit connection of a variety of external control methods. Terminals, dimensions, and key components are illustrated in Figure 1-2.

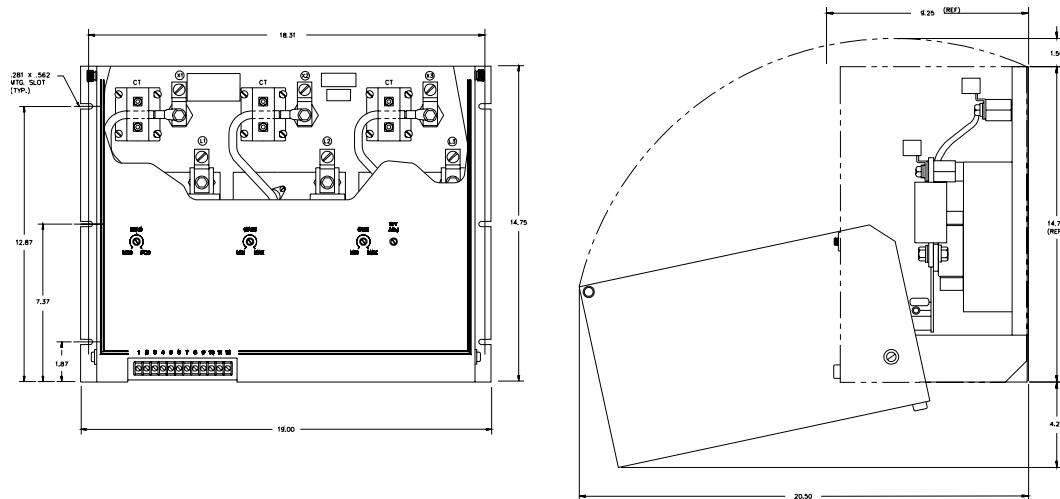

Figure 1-2. Front, Cutaway and Side Views of a Typical 25A to 225A 3PCI Controller

1.2. Operation

The 3PCI accomplishes phase fired control by the switching action of three pairs of inverse-parallel power SCRs. The switching, or gating, of the SCRs is controlled by a digital firing control circuit synchronized “in phase” with the line frequency (either 50 or 60 Hz). The digital firing circuit may be manually controlled by the BIAS control, or automatically or manually controlled by one of several external methods. Screwdriver-adjusted BIAS and GAIN controls are used to set up the 3PCI for operation by external control. Chapter 3: Operation describes how to implement the various control methods.

1.3. Three-phase Overcurrent (OC) Trip Feature

The three-phase overcurrent trip (OC) feature provides circuit protection from output current overloads by serving as a fast-gate shutdown. (OC functions similar to an electronic fuse.) The trip point is adjustable from 25% to 200% of the SCR power controller’s rating. Current transformers on the SCR power controller’s output lines allow option OC to monitor instantaneous peak current. When the peak current level exceeds the preset trip level, SCRs are gated off, and the load current is shut down within a half cycle. The TRIP RESET push-button can be configured for automatic or manual reset to resume operation. See Section 4.5: Adjusting the Overcurrent (OC) Feature.

The overcurrent (OC) feature is used mainly for the fuseless RF generator design (model RF3PI). The leakage impedance (LZ) and the transformer’s maximum KVA determine what maximum thermal-rated current power controller will be needed. Additional connections need to be made from the OC relay contact and the customer’s circuit breaker or the plate contactor.

The OC feature shuts down the controller within the first half cycle of fault current. Then the overcurrent relay opens the circuit breaker or plate contactor to clear the fault. For a fused design, the fuse will open at the same time the OC feature trips. This feature is not recommended for fused designs.

To adjust the overcurrent (OC) feature, follow the instructions listed in Chapter 4: Options Setup.

Overcurrent (OC) trip relay contacts are available at terminals **TB2-40**, **TB2-41** and **TB2-42**.

1.4. Three-phase Current Limit (CL) Feature

The 3-phase current limit (CL) feature prevents the output current of an SCR power controller from exceeding a preset maximum current level, as determined by the current limit control setting (5% to 125%). Current

transformers monitor the true rms current, and feed the information to option CL, which limits the true rms current regardless of the process control signal.

1.5. Options

Several options are available on the 3PCI. Several of these options are listed below and explained in the subsections that follow.

- Three-phase Current Regulation (CR) Option
- Current Imbalance Detection (CID) Option
- Lug Kit (LK) Option
- Extended Ramp (ER) and Fast Ramp (FR) Options.

Most options require current transformers (CTs), which are standard on models rated from 25 A through 225 A. CTs are shipped separately on models rated from 350 A and higher.



1.5.1. Three-phase Current Regulation (CR) Option

The 3-phase Current Regulation (CR) option compares the feedback signal to the control signal, so the line current will be linear to the control signal, and regulated to maintain a constant current level at the controller output despite load changes. Current regulation is adjustable from 5% to 125% of the CT rating.

1.5.2. Current Imbalance Detection (CID) Option

The Current Imbalance Detection (CID) option continuously compares the load currents of each phase. When an imbalance exceeds a pre-determined limit value (5% to 50%), a set of form-C contacts may be used to alarm and/or turn off the process.

1.5.3. Lug Kit (LK) Option

If required by an application, an optional lug kit (Option LK) is offered. Lug kits are available on 350 A through 1200 A units. Lugs are provided on 25 A through 225 A units.

1.5.4. Extended Ramp (ER) and Fast Ramp (FR) Options

The increasing rate of the output voltage RMS value is limited to prevent high inrush currents with transformer-coupled loads or with elements having high cold-to-hot resistance ratios. With a nominal gain setting, the rate of increase is limited to approximately 100% per second. Additional protective circuits prevent excessive output bursts due to the fluctuations of re-applied AC source voltage.

The standard ramp time is 1 second. By specifying option ER, the soft-start ramp is increased to 4 seconds. A fast ramp option (FR) reduces the ramp time to 0.100 seconds (100 ms).

1.6. Technical Specifications

Specifications for the 3PCI SCR Power Controller are given in Table 1-2 and Table 1-1.

Table 1-1. General Technical Specifications

Item	Description
Input line voltage ¹	208, 240, 400, 480, 600 V _{AC} (+10%, -20%) 3-phase
Line frequency ¹	50/60 Hz (no circuit change is necessary for either)
Current rating ¹	25 A _{AC} or 1200 A _{AC} per model number (see Table 1-2)
Thermostat contact rating	120 V _{AC} , 5 A, resistive
Input signal	Galvanic isolation: 0-1.5 V (min) 0-15 V (max)

Item	Description															
	0-1 mA (min) 0-3 mA (max) 0-3 mA (min) 0-30 mA (max) ² Control methods: 1. Potentiometer ³ (5 k Ω , 0.5 watt) 2. Dry contact closure ³ 3. Temperature or process controller ⁴															
Control signal input impedance ¹	Non isolated input (galvanic isolation); 250 Ω , 0.5 watt standard															
Control signal isolation	From SCRs: 2,500 V _{DC} From AC power input lines: 2,500 V _{DC} 2,200 V _{AC} From chassis: 500 V _{DC} 1,000 V _{AC}															
Power output	Voltage regulation: $\pm 0.5\%$ per $\pm 10\%$ line voltage change Linearity vs. Control signal input: $\pm 2\%$ (galvanic isolation)															
Power SCRs protection	Current surge: Subcycle I ² T semiconductor fuse Transient voltage spikes (dV/dt): Metal oxide varistor (MOV) and RC snubber across each SCR pair; all SCRs have PIV rating of 1,400 V.															
Output voltage change vs. Ambient temperature change	0.18% per °F 0.10% per °C															
Phase-firing time base	0° to 180° conduction per SCR															
Controls (pots)	3 (bias, gain and current limit) multi-turn, screwdriver-adjustable pots															
Fan cooling power	<table border="0"> <thead> <tr> <th></th> <th>50 Hz Unit</th> <th>60 Hz Unit</th> </tr> </thead> <tbody> <tr> <td>90-225 A units:</td> <td>0.42 A, 50 VA</td> <td>0.38 A, 46 VA</td> </tr> <tr> <td>350-500 A units:</td> <td>0.63 A, 76 VA</td> <td>0.57 A, 69 VA</td> </tr> <tr> <td>650-1200 A units:</td> <td>4.2 A, 504 VA</td> <td>3.6 A, 432 VA</td> </tr> </tbody> </table>		50 Hz Unit	60 Hz Unit	90-225 A units:	0.42 A, 50 VA	0.38 A, 46 VA	350-500 A units:	0.63 A, 76 VA	0.57 A, 69 VA	650-1200 A units:	4.2 A, 504 VA	3.6 A, 432 VA			
	50 Hz Unit	60 Hz Unit														
90-225 A units:	0.42 A, 50 VA	0.38 A, 46 VA														
350-500 A units:	0.63 A, 76 VA	0.57 A, 69 VA														
650-1200 A units:	4.2 A, 504 VA	3.6 A, 432 VA														
Ambient temperature range	Operation: 32°F to 122°F (0°C to 50°C) Storage: 14°F to 158°F (-10°C to 70°C)															
Weight	<table border="0"> <thead> <tr> <th>Current Rating</th> <th>lbs</th> <th>Kg</th> </tr> </thead> <tbody> <tr> <td>25 through 225 A units</td> <td>40</td> <td>18.2</td> </tr> <tr> <td>350 through 500 A units</td> <td>60</td> <td>27.3</td> </tr> <tr> <td>650 A units</td> <td>126</td> <td>57.3</td> </tr> <tr> <td>800 through 1,200 A units</td> <td>231</td> <td>105.0</td> </tr> </tbody> </table>	Current Rating	lbs	Kg	25 through 225 A units	40	18.2	350 through 500 A units	60	27.3	650 A units	126	57.3	800 through 1,200 A units	231	105.0
Current Rating	lbs	Kg														
25 through 225 A units	40	18.2														
350 through 500 A units	60	27.3														
650 A units	126	57.3														
800 through 1,200 A units	231	105.0														

1 - Must be specified with order

2 - With 250 Ω input impedance

3 - Supplied by customer

4 - If a temperature/process controller will be used, provide its output specifications when the order is placed (e.g., 4-20 mA, 0-10 V_{DC}, 2-10 V_{DC}, etc.).

Table 1-2. 3PCI Model Number Code Descriptions

3PCI-__	-__	-CL/OC-D-__	-__	-__	-__
Voltage (Volts)	Current (Amps)	Input Type	General Options	Ramp Rate Options	Optional Lug Kit
20=208 V 24=240 V 40=380/415 V 48=480 V 60=600 V	25 40 60 90 120 180 225 350 500 650 800 1000 1200	1=0-5 mA 2=0-20 mA 3=0-50 mA 4=1-5 mA 5=4-20 mA 6=12-20 mA 7=0-5 VDC 8=0-10 VDC 9=pot input	CID = Current imbalance detection CR = Current regulation	FR =0.100 sec ER = 4.000 sec	blank LK ¹

¹ - Add "LK" if lugs are required for 350-1200 A units. Lugs are standard on 15-225 A units. If left blank, lug kit is not added.

Voltage and current ratings are implicit in the model number as shown in the above table.



▽ ▽ ▽

CHAPTER 2: INSTALLATION

In This Section:

- Mounting the 3PCI2-1
- Fan Wiring (Models Rated at 90 A and Higher).....2-1
- Wiring Overtemperature Contacts2-1
- Input/Output Wiring.....2-1
- Adjusting the Overcurrent (OC) Feature.....2-1
- Internal 3PCI Connections.....2-4

2.1. Mounting the 3PCI

Determine the voltage and current ratings from the nameplate of the unit (refer to Table 1-2 on page 2-5). Then determine space and mounting hole requirements by referring to the appropriate outline drawing (located at the end of this manual) that applies to your model's current rating. Mount the unit so that the line and load connections are at the top and ensure that upward air flow over the heat sink fins is unrestricted. On high current models, allow adequate clearance for routing the relatively large diameter input and output lines.

Caution! Printed circuit boards contain sensitive components that can be damaged by electrostatic discharge (ESD). The 3PCI power controllers are shipped from the factory wrapped in static-free packing materials. Avoid handling the printed circuit board unless ESD protection has been observed. Details concerning ESD protection can be found in Section 5.3: Static Precautions When Servicing on page 5-1 in the Troubleshooting section of this manual.



2.2. Fan Wiring (Models Rated at 90 A and Higher)

3PCI models with cooling fans require 120 Vac power which must be supplied by the customer. Power requirements are shown in Table 1-1 on page 1-3.

The 3PCI terminals available for the 120 Vac fan connections are shown in the drawings at the rear of this manual. Locate the correct drawing for your model's current rating.

Caution! The application of fan power should precede, or coincide with, the turn-on of the line voltage source that is to be controlled by the 3PCI. How this is accomplished and ensured is up to the customer.



2.3. Wiring Overtemperature Contacts

Normally-open (N.O.) heat sink thermostats are standard on all fan-cooled models (rated 90 A and higher). These thermostats, which close on high heat sink temperature (200° F), may be used to initiate an alarm, shunt trip, or other device for SCR protection.

If desired, normally-closed (N.C.) contacts may be ordered rather than normally-open (standard). Heat sink thermostats are optional on units with current ratings lower than 90 A, and can be ordered with either N.O. or N.C. contacts.

2.4. Input/Output Wiring

Using appropriately sized and insulated conductors for the voltage and current ratings of your model, make connections as shown in Figure 2-1 and Figure 2-2. (Refer to Table 2-1 on page 2-2 for wire size information.) Torque specifications of bolted connections can be found in Table 5-3 and Table 5-4 starting on page 5-5.

Wiring rated at 75°C is required for all 3PCI model current ratings.

The 3PCI is phase-rotation insensitive. That is, three-phase input power can be connected in any sequence to terminals L1, L2, and L3, and will not cause an out-of-phase condition.

Warning! Branch circuit overcurrent protection required is to be provided in accordance with the national and local codes of the inspecting authority.

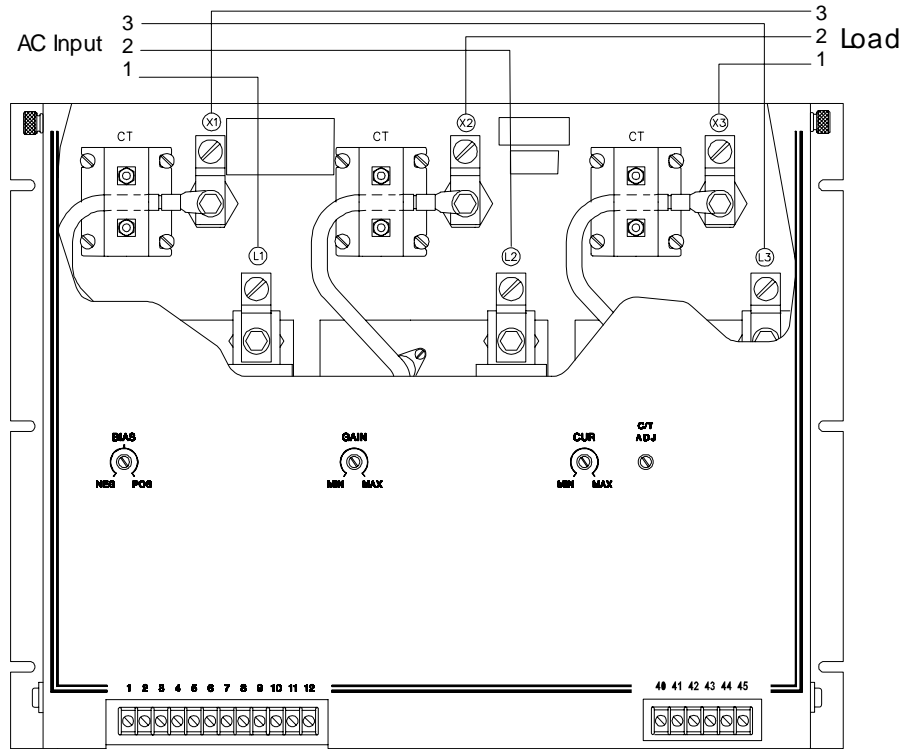

Figure 2-1. Typical 3PCI Line and Load Connections

Table 2-1. Wire Size Information

Current Rating	Smallest Allowable Conductor Size		Largest Allowable Conductor Size	
60, 90 and 120 A	8 AWG	Terminal	0 AWG	Terminal
180 and 255 A	6 AWG		250 MCM ¹	
350 through 1,200 A	n/a		n/a	

1 - 1 MCM = 1000 CM (circular mils)

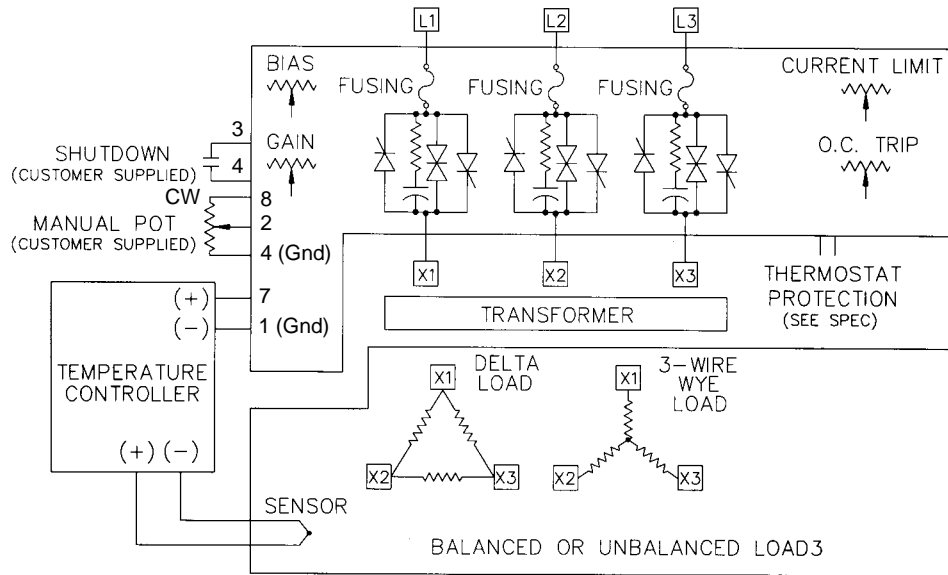

Figure 2-2. Input and Output Connections Overview for the 3PCI

Table 2-2. Terminal Block Specifications

Pin #	Description	Terminal Block
1	Common	
2	Voltage input	
3	Shutdown	
4	Common	
5	+15 VDC	
6	-15 VDC	
7	+ mA input	
8	+10 VDC	
9	External feedback	
10		
11	+26 VDC	
12		
40	N.C. OC relay	
41	Common OC relay	
42	N.O. OC relay	
43	OC reset	
44	OC reset	
45		

2.5. Internal 3PCI Connections

Before operating the 3PCI, the customer must determine which control signal is used. The 3PCI will operate at 50/60 Hz with no circuit changes required.



CHAPTER 3: OPERATION

In This Section:	
• Introduction	3-1
• Internal Manual Control of Power Output	3-1
• Temperature Controller	3-2
• Remote Manual Control (Only) with a Potentiometer	3-2
• Auto/Manual Control with a Controller and Remote Potentiometer	3-3
• On/Off Control	3-3
• Controlling Several 3PCIs in Parallel with One Controller	3-4

3.1. Introduction

This section provides information necessary for proper setup and operation of various methods used to control the 3PCI. These methods are:

1. Internal manual control of power output
2. Temperature controller
3. Remote manual control (only) with a potentiometer
4. Auto/manual control with a controller and potentiometer
5. On/off control
6. Controlling several 3PCIs connected in parallel.

3.2. Internal Manual Control of Power Output

The 3PCI should be tested and operated with an adequate load since an open output will have line voltage at the load connections.



For the following procedures, measurements of the output voltage should be made with an analog voltmeter or a digital voltmeter that reads true rms.



Warning! Hazardous voltages exist at the 3PCI output terminals and at the load when the input voltage is connected—even when the 3PCI is set to deliver zero output by any of the control methods described in this section. The line input fused disconnect or circuit breaker must be “open” or “off” (including at the load) to perform maintenance of any kind.



Prior to shipment the 3PCI unit is configured at the factory according to the customer’s requirements. If no requirements are specified, the standard unit is configured for 4-20 mA operation into a 250 Ω impedance. see Table 3-1.

Table 3-1. Matching SCR Power Control to an External Controller Signal

Source Type	Ranges	Input Impedance
Voltage input	0-1.5 V, 0-15 V, 1-5 V, 2-10 V	> 100 KΩ ¹
Current input	0-1 mA, 0-3 mA, 0-30 mA, 4-20 mA	250 Ω ¹

1 - Consult the factory for other input impedances.

3.3. Temperature Controller

A wide range of controller outputs can be used to drive the 3PCI. The range of acceptable full scale output voltages is from a minimum of 0-5 VDC to a maximum of 10 VDC. Since most controllers have a current output, the input impedance of the 3PCI on **TB1-1** (-) and **TB1-2** (+) is 0.05 to 10 VDC for voltage control. For milliamp control, connect to **TB1-1** (-) and **TB1-7** (+). Input impedance is 250 Ω.

Although the 3PCI unit is factory set for control as specified on the unit's decal, temperature control calibration may be performed as follows:

1. Connect a 4-20 mA_{DC} control signal to **TB1-7** (+ input) and **TB1-1** (- input) as shown in Figure 3-1.
2. Using a voltmeter to monitor output voltage, adjust the bias control until some voltage is seen. Then adjust the bias counter-clockwise (CCW) until the output voltage is as close to zero as possible.
3. Set the temperature controller to demand 100% output. Observing the voltmeter, adjust the gain until the voltage reading is slightly below the maximum output voltage.
4. Repeat the previous steps to ensure that the proper control adjustments have been made.
5. Turn off the line power to the 3PCI and disconnect the test equipment. The 3PCI is now ready for automatic operation.

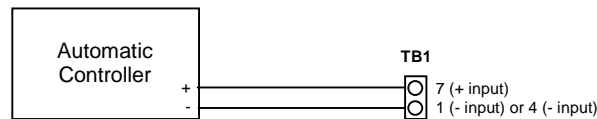

Figure 3-1. Automatic Controller Input Connections

3.4. Remote Manual Control (Only) with a Potentiometer

This potentiometer may be located on a remote panel near other controls related to the process being powered by the 3PCI. It may be calibrated to correspond to a percentage of rated power output, process temperature, or some other parameter. The potentiometer may be 500 Ω to 5 kΩ, and should be rated at 0.5 watt, minimum.

1. With the power to the 3PCI turned off, connect the potentiometer as shown in Figure 3-2. The CW position is the full power output position. Terminal **TB1-8** is internally connected to a positive DC voltage source.
2. Connect an analog voltmeter across terminals **x1**, **x2**, or **x3**. Set the voltmeter range to measure the full output voltage.
3. Set the remote potentiometer fully CCW.
4. Close the fused disconnect or circuit breaker to apply power to the 3PCI. The unit should be energized, with no output.
5. Adjust the bias control for zero output voltage.
6. Adjust the manual pot fully CW. Adjust the gain control for maximum output voltage.

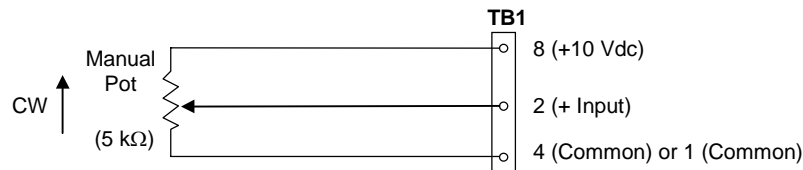

Figure 3-2. Remote Control with a Potentiometer



Caution - Electrical Hazard! Hazardous voltages exist at the exposed 3PCI heat sinks and at the load unless the line-source fused disconnect or circuit breaker is open or off. This is true even when the SCRs are turned off. Always remove power to the unit before attempting service.

3.5. Auto/Manual Control with a Controller and Remote Potentiometer

Following the instructions detailed in the previous section (Section 3.4: Remote Manual Control (Only) with a Potentiometer), select and install the remote potentiometer. Install the AUTO/MAN switch in the same general location as the remote manual potentiometer.

With the power to the 3PCI turned off, connect the switch, potentiometer, and controller as shown in Figure 3-3. Note that the full CW position of the potentiometer is the full-power output position.

Place the AUTO/MAN switch to AUTO and calibrate the system as outlined in Section 3.3: Temperature Controller on page 3-2.

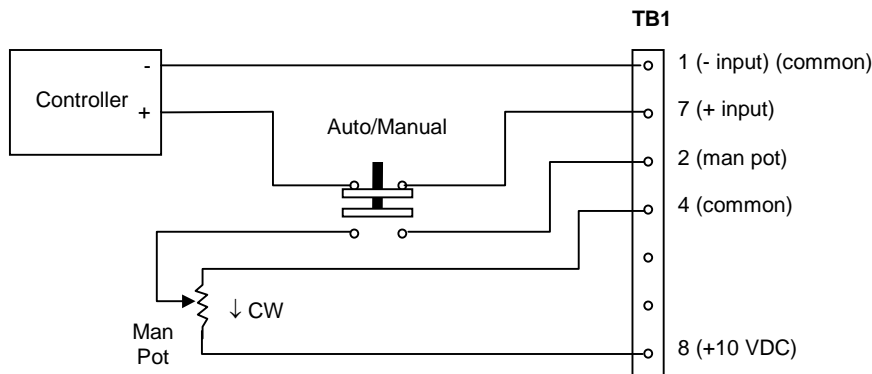

Figure 3-3. Auto/Manual Control with Controller and Remote Potentiometer

3.6. On/Off Control

Two methods of on/off control are provided:

1. Output enabled by contact closure
2. Output disabled by contact closure.

3.6.1. Output Enabled by Contact Closure

With the power to the 3PCI turned off, connect the system as shown in Figure 3-4. Calibrate the system as outlined in Section 3.3: Temperature Controller on page 3-2. Note that zero power demand is accomplished by opening the contacts with the controller, and maximum power demand is present when the contacts are closed.

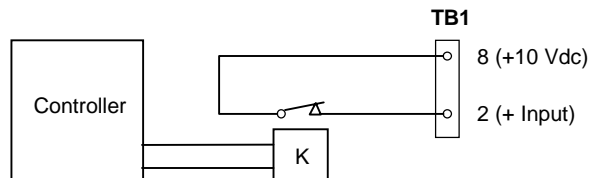

Figure 3-4. On/Off Control with Output Enabled by Contact Closure

3.6.2. Output Disabled by Contact Closure

With the power to the 3PCI turned off, connect the system as shown in Figure 3-5.

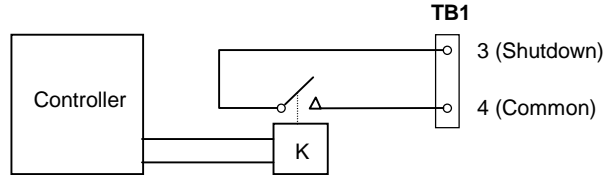

Figure 3-5. On/Off Control with Output Disabled by Contact Closure

Calibrate the system as outlined in Section 3.3: Temperature Controller on page 3-2. Note that zero power demand is accomplished by closing the contacts with the controller, and maximum power demand is present when the contacts are open.

3.7. Controlling Several 3PCIs in Parallel with One Controller

Multiple control of parallel connected 3PCIs with a single controller is outlined below.

1. Connect each unit as shown in Figure 3-6. Refer to Section 3.3: Temperature Controller on page 3-2.
2. Remove the external shunt resistor **R101** on all of the units.
3. Connect the remaining units in parallel as shown in Figure 3-6.
4. Connect the appropriate impedance matching resistor (RC) for your controller across the output terminals of the controller as shown in Figure 3-6. This will assure proper operation of all controllers. RC is usually 250Ω or 500Ω.
5. Calibrate the system as outlined in Section 3.3: Temperature Controller on page 3-2.

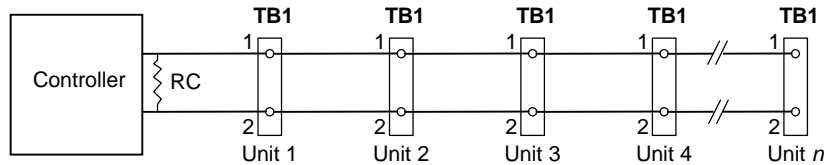

Figure 3-6. Controlling Several 3PCIs Connected in Parallel



CHAPTER 4: OPTIONS SETUP

In This Section:	
• Introduction	4-1
• Option CL (3-phase Current Limit)	4-1
• Option CID (Current Imbalance Detector)	4-1
• Reset Push-button	4-1
• Adjusting the Overcurrent (OC) Feature.....	4-1

4.1. Introduction

This section describes the setup procedures for the following 3PCI options:

- Option CL (3-phase current limit) setup
- Option CID (current imbalance detector) calibration
- Reset push-button setup (user supplied).

4.2. Option CL (3-phase Current Limit)

Refer to Chapter 3: Operation and review the appropriate setup procedures for the BIAS and GAIN controls. Then adjust option CL as follows:

1. Adjust the CURRENT LIMIT potentiometer fully CW.
2. Adjust BIAS and GAIN as previously described in Chapter 3: Operation.
3. Adjust the CURRENT LIMIT potentiometer full CCW.
4. Increase the input control signal to demand full output.
5. Adjust the CURRENT LIMIT potentiometer until maximum current level is reached.

4.3. Option CID (Current Imbalance Detector)

A separate box is included if the CID option is specified. For calibration information, refer to data shipped with the CID option.

4.4. Reset Push-button (User Supplied)

1. Connect a normally-closed (N.C.) push-button switch to **TB2**, terminals 43 and 44.
2. Remove jumper **J2** from the printed circuit board.

Overcurrent (OC) trip relay contacts are available at terminals **TB2-40**, **TB2-41** and **TB2-42**.



4.5. Adjusting the Overcurrent (OC) Feature

To adjust the overcurrent (OC) feature, follow the instructions below.

1. Run the unit in a normal load configuration and adjust the current trip (CT) adjustment clockwise (CW) until the unit starts to trip.
2. Then adjust the current trip (CT) adjustment counter-clockwise (CCW) until steady operation starts.
3. Turn the current trip (CT) adjustment counter-clockwise (CCW) another quarter turn.

Overcurrent (OC) trip relay contacts are available at terminals **TB2-40**, **TB2-41** and **TB2-42**.



CHAPTER 5: TROUBLESHOOTING

In This Section:

- Customer Service Program 5-1
- Troubleshooting Typical Symptoms.... 5-1
- Static Precautions When Servicing..... 5-1
- Environmental Problems..... 5-2
- Input Power and Load Connections.... 5-3
- Correcting Specific 3PCI Problems 5-3
- Replacement Fuses 5-4
- Torque Specifications 5-4

5.1. Customer Service Program

Although service is seldom necessary, because of the inherent long-term reliability of solid-state components and conservative design, ASI Robicon emphasizes customer satisfaction by maintaining a rapid-response, cooperative customer-service. If operational difficulties occur, ASI Robicon will provide replacement parts or units quickly, courteously and efficiently. If servicing problems arise that are not within the scope of the following troubleshooting guide, service is readily available, as detailed Chapter 6: Service.

5.2. Troubleshooting Typical Symptoms

The 3PCI is considered to be operating properly when it's output voltage can be satisfactorily varied from 0% to 100% of the available input voltage by a control signal. Improper operation of the unit is usually indicated by one of the following symptoms:

1. No output.
2. Full output at all times, with no change resulting from a control signal change.
3. Output variable from some intermediate value to maximum, but cannot be brought to zero.
4. Output variable from zero to some intermediate value, but cannot be brought to maximum.

The symptoms listed may be caused by one or more of the following: an environmental problem, faulty input-power or load connections, and the 3PCI itself. These possible causes should be investigated as described in sections that follow.

The 3PCI should be tested and operated with an adequate load since an open output will have line voltage at the load connections.



5.3. Static Precautions When Servicing

Servicing should be performed by qualified personnel only, following procedures described herein.

Caution - Electrical Hazard! Hazardous voltages exist at the exposed 3PCI heat sinks and at the load unless the line-source fused disconnect or circuit breaker is open or off. This is true even when the SCRs are turned off. Always remove power to the unit before attempting service.



If troubleshooting indicates a need to replace a component on a printed circuit board or possibly the entire board, measures to prevent electrostatic discharge (ESD) damage must be taken.



ESD Sensitive Equipment!

Always be aware of electrostatic discharge (ESD) when working near or touching 3PCI components. Printed circuit boards contain components that are sensitive to static electricity. Handling and servicing of components that are sensitive to ESD should be done only by qualified personnel and only after reading and understanding proper ESD techniques. The following ESD guidelines should be followed. Following these rules can greatly reduce the possibility of ESD damage to PC board components.

- Make certain that anyone handling the 3PCI printed circuit boards is wearing a properly grounded static strap. The wrist strap should be connected to ground through a 1 megohm resistor. Grounding kits are available commercially through most electronic wholesalers.
- Static charge buildup can be removed from a conductive object by touching the object to a properly grounded piece of metal.
- Always transport static sensitive equipment in antistatic bags or along static shielding rails. A part that is completely installed on a board does not make the part static-safe.
- When handling a PC board, always hold the card by its edges.
- Do not slide printed circuit boards across any surface (e.g., a table or work bench). If possible, perform PCB maintenance at a workstation that has a conductive covering which is grounded through a 1 megohm resistor. If a conductive tabletop cover is unavailable, a clean steel or aluminum tabletop is an excellent substitute.
- Avoid plastic, Styrofoam™, vinyl and other non-conductive materials. They are excellent static generators and do not give up their charge easily.
- Always use a soldering iron that has a grounded tip. Also, use either a metallic vacuum-style plunger or copper solder removal braid when desoldering.
- When returning components to ASI Robicon, always use static-safe packing. This limits any further component damage due to ESD.

5.4. Environmental Problems

Many reported problems with the 3PCI are the result of environmental issues. Below is a list of common environmental problems that may cause problems with the operation of the 3PCI. Ensure that none of the following environmental problems exist.

- Inadequate cooling
- Contamination
- High ambient temperatures
- Excessive vibration.

5.4.1. Inadequate Cooling

For models with separate power and trigger modules, allow at least an inch of air space (in any direction) between the heat sinks and any item or structure near the 3PCI power modules. Heat sink fins should be free of dust or dirt for proper heat transfer, and free of obstructions which could prevent proper airflow.

5.4.2. Contamination

The unit should be periodically cleaned of all dust and dirt. However, certain kinds of dust or particles are particularly conductive. A small accumulation of conductive material can cause component failures from arcing or complete shorts.

5.4.3. High Ambient Temperature

Lack of a proper ambient-temperature check before installation, or an increase in ambient temperature, can result in numerous problems. Check the ambient temperature under existing conditions. If it is 122°F (50°C) or lower, ambient temperature should not be a problem. If it is above 122°F (50°C), steps should be taken to

provide more cooling, or the 3PCI should be moved to a cooler location, or call the ROBICON service department.

5.4.4. Excessive Vibration

A significant degree of pitched or unpitched vibration can cause numerous problems. If vibration is isolated as a probable cause of improper operation, standard vibration-isolation mounting techniques should be employed.

5.5. Input Power and Load Connections

Turn off the power to the 3PCI and check all power connections, input and output, to make sure they are mechanically secure and free of corrosion. Make the same checks at the power source and load. Visually check insulation on input and load wiring for evidence of damage or overheating.

5.6. Correcting Specific 3PCI Problems

Table 5-1 provides a comprehensive guide for troubleshooting the 3PCI. Refer to this table for possible causes and solutions.

Table 5-1. 3PCI Troubleshooting Symptoms and Solutions

Symptom	Possible Cause(s)	Possible Solution(s)
1. No output—even with manual control (BIAS) turned full CW.	(a) System has an open SCR fuse. (b) SCRs are not firing.	(a) Remove and check the fuse. If it has opened, replace it <u>after</u> completing (b). (b) Install a good fuse in the circuit, and apply power to the 3PCI. If the output is fully controllable using the manual control, then resume normal operation. If the power output is still zero, contact ROBICON service.
2. Output is variable, but cannot be brought to zero with bias control.	(a) SCR network shorted. (b) Firing control section defective.	(a) Check SCR network per solution listed below in solution 4(a). (b) Contact ROBICON service for assistance.
3. Output is variable, but cannot be brought to maximum with GAIN control.	(a) Firing control section defective.	(a) Contact ROBICON service for assistance.
4. Maximum power at all times regardless of the control setting.	(a) All SCR networks are shorted. (b) Firing control section defective.	(a) On units rated above 225 A: Remove the fuse and check the front-to-back SCR pairs by measuring resistance between the cathode of the SCR being checked and an unanodized portion of the heat sink. On the R×1 scale, the resistance should be infinite in both directions. If a shorted component is indicated in any of these checks,

Symptom	Possible Cause(s)	Possible Solution(s)
		replace it. On units rated at 225 A and below: Remove the fuse and check the front-to- back SCR pairs by measuring resistance between terminals L1 (of the SCR) and x1. On the R×1 scale, the resistance should be infinite in both directions. If a shorted component is indicated in any of these checks, replace it.

5.7. Replacement Fuses

Table 5-2 lists the replacement fuses for the various 3PCI models. The 3PCI may come supplied with fuses having identifying numbers different from the numbers shown in the table. In such a case, the fuse may be replaced either with an identical fuse or the one shown in the table.

Table 5-2. Fuse Specifications

Amperes	Vendor Part Numbers		
	Buss	Gould-Shawmut	Carbone-Ferraz
25	FWP-40	A70P40	A070F040
40	FWP-60	A70P60	A070F060
60	FWP-125A	A70P125	A070F125
90	FWP-125A	A70P125	A070F125
120	FWP-150A	A70P150	A070F150
180	FWP-225A	A70P225	A070F225
225	FWP-300A	A70P300	A070F300
350	FWP-450A	<i>n/a</i>	A070F450
500	FWP-600A	A70P600	A070F600
650	FWP-800A	A70P800	A070F800
800	FWP-1000A	A70P1000	A070F1000
1000	FWP-1200A	A70P1200	A070F1200
1200	<i>n/a</i>	A70P1600	<i>n/a</i>

5.8. Torque Specifications

Torque specifications for 3PCI connections are given in Table 5-3 and Table 5-4.



Attention! All input and output conductors should have a minimum temperature rating of 75°C.

Table 5-3. Torque Specifications Based on Conductor Sizes

Input/Output Conductor Size ¹	Torque for Slot Width ² ≤ 0.25"	Torque for Slot Width ² > 0.25"	Torque for Hex Head
6-4 AWG	35 inch-pounds	45 inch-pounds	110 inch-pounds
2 AWG	40 inch-pounds	50 inch-pounds	150 inch-pounds
1 AWG	<i>n/a</i>	50 inch-pounds	150 inch-pounds
1/0 to 2/0 AWG	<i>n/a</i>	50 inch-pounds	180 inch-pounds
3/0 to 4/0 AWG	<i>n/a</i>	<i>n/a</i>	250 inch-pounds
250 CM to 350 CM	<i>n/a</i>	<i>n/a</i>	325 inch-pounds

1 - Given in AWG or circular mils (CM)

2 - Screwdriver blade width to match

Table 5-4. Torque Specifications Based on Socket Sizes (For All Conductor Sizes)

Socket Size ³	Torque
3/16"	120 inch-pounds
1/4"	200 inch-pounds
5/16"	275 inch-pounds
3/8"	375 inch-pounds
1/2"	500 inch-pounds

3 - Socket-head size measured across flats

▽ ▽ ▽

CHAPTER 6: SERVICE

In This Section:

- How to Contact ASIRobicon6-1
- Spare Parts6-1
- Drawing List6-3

6.2. Spare Parts

Requests for spare parts should be directed to Argo International Corporation at 212-431-2210. When requesting spare parts, please provide the related equipment model number and serial number, the required part name and any identifying part or vendor number(s), and your time needs. An approved purchase order number should be given with your order.

Table 6-1 lists the minimum recommended quantities for spare parts for the 3PCI. As spares are used, replacements should be ordered.

The listed SCR current ratings are the half-wave average value. The calculation for half-wave AVG value is nameplate current times 0.45.

Table 6-1. Spare Parts

Amps	Item Description	Item #	Qty
25 A	Fuse, 40 A, 500 V	261277.00	3
	PCB assembly, 3PCI trigger	469196.xx	1
	PCB assembly, SCR module #1, *DVDT VAR*	H023870	3
	SCR/dual package, 92 A, 1400 V	H011024	3
40 A	Fuse, 60 A, 700 V	261277.25	3
	PCB assembly, 3PCI trigger	469196.xx	1
	PCB assembly, SCR module #1, *DVDT VAR*	H023870	3
	SCR/dual package, 92 A, 1400 V	H011024	3

Amps	Item Description	Item #	Qty
60 A	Fuse, 125 A, 700 V	261277.30	3
	PCB assembly, 3PCI trigger	460T41.00	1
	PCB assembly, SCR module #1, *DVDT VAR*	H023870	3
	SCR/dual package, 92 A, 1400 V	H011024	3
90 A	Fan, axial, 115 Vac, 110 CFM	H018659	2
	Fuse, 125 A, 700 V	261277.30	3
	PCB assembly, 3PCI trigger	460T41.00	1
	PCB assembly, SCR module #1, *DVDT VAR*	H023870	3
	SCR/dual package, 92 A, 1400 V	H011024	3
120 A	Fan, axial, 115 Vac, 110 CFM	H018659	2
	Fuse, 150 A, 700 V	261277.31	3
	PCB assembly, 3PCI trigger	460T41.00	1
	PCB assembly, SCR module #1, *DVDT VAR*	H023870	3
	SCR/dual package, 92A, 1400 V	H011024	3
180 A	Fan, axial, 115 Vac, 110 CFM	H018659	2
	Fuse, 225 A, 700 V	H018813	3
	PCB assembly, 3PCI trigger	460T41.00	1
	PCB assembly, SCR module #2, *DVDT VAR*	H023871	3
	SCR/dual package, 142 A, 1400 V	H017371	3
225 A	Fan, axial, 115 Vac, 110 CFM	H018659	2
	Fuse, 300 A, 700 V	261277.34	3
	PCB assembly, 3PCI trigger	460T41.00	1
	PCB assembly, SCR module #2, *DVDT VAR*	H023871	3
	SCR/dual package, 162 A, 1400 V	H019070	3
350 A	Fan, axial, 115 Vac, 110 CFM	H018659	3
	Fuse, 450 A, 700 V	H019253	3
	Lug kit, single-phase 350 A, CSA certified	H020477	3
	PCB assembly, 3PCI trigger	460C17.xx	1
	PCB assembly, *DVDT VAR*	H028485	3
	SCR, 298 A, 1400 V	068237	6
	Varistor, 660 V	H026669	3
500 A	Fan, axial, 115 Vac, 110 CFM	H018659	3
	Fuse, 600 A, 700 V	261277.38	3
	Lug kit, single-phase 500 A, CSA certified	H020478	3
	PCB assembly, 3PCI trigger	460C17.xx	1
	PCB assembly, *DVDT VAR*	H028485	3
	SCR, 508 A, 1400 V	H020035	6
	Varistor, 660 V	H026669	3
650 A	Fan, axial, 115 Vac, 350 CFM	074892	3
	Fuse, 800 A, 700 V	261277.40	3
	Lug kit, single-phase 650 A, CSA certified	H020479	3
	PCB assembly, 3PCI trigger	460C17.xx	1
	PCB assembly, *DVDT VAR*	H028607	3
	SCR, 589 A, 1400 V	261300.34	6
	Varistor, 660 V	H026669	3

Amps	Item Description	Item #	Qty
800 A	Fan, axial, 115 Vac, 350 CFM	074892	3
	Fuse, 1000 A, 700 V	261277.42	3
	Lug kit, single-phase .8-1.2kA, CSA certified	H020760	3
	PCB assembly, 3PCI trigger	460C17.xx	1
	PCB assembly, *DVDT VAR*	H028607	3
	SCR, 719 A, 1400 V	H020037	6
	Varistor, 660 V	H026669	3
1000 A	Fan, axial, 115 Vac, 350 CFM	074892	3
	Fuse, 1200 A, 700 V	261074.43	3
	Lug kit, single-phase 0.8-1.2kA, CSA certified	H020760	3
	PCB assembly, 3PCI trigger	460C17.xx	1
	PCB assembly, *DVDT VAR*	H028607	3
	SCR, 1329 A, 1400 V	H020038	6
	Varistor, 660 V	H026669	3
1200 A	Fan, axial, 115 Vac, 350 CFM	074892	3
	Fuse, 1600 A, 700 V	H013430	3
	Lug kit, single-phase .8-1.2kA, CSA certified	H020760	3
	PCB assembly, 3PCI trigger	460C17.xx	1
	PCB assembly, *DVDT VAR*	H028607	3
	SCR, 1329 A, 1400 V	H020038	6
	Varistor, 660 V	H026669	3

Note: The .xx suffix found on some item numbers listed in the previous table corresponds to revision numbers for customer-specific products.

6.3. Drawing List

This section contains drawings that show outline dimensions, installation wiring, and printed circuit board component locations, as well as an overall schematic of the 3PCI. These drawings are useful in installing and troubleshooting all 3PCI models. Table 6-2 lists the drawings in the order of their appearance.

Table 6-2. Drawing List

Drawing #	Drawing Title
405816	Outline and Mounting, 3PCI: 25 A through 40 A
478113	Schematic, 3PCI: 25 A through 40 A
405492	Outline and Mounting, 3PCI: 60 A through 225 A
477882	Schematic, 3PCI: 60 A through 225 A
405498	Outline and Mounting, 3PCI: 350 A through 500 A
478096	Schematic, 3PCI: 350 through 500 A
405493	Outline and Mounting, 3PCI: 650 A
405497	Outline and Mounting, 3PCI: 800 A through 1200 A
477883	Schematic, 3PCI: 650 through 1200 A

▽ ▽ ▽

**TITLE: Instructions for Configuring the 3PCI Gate Trigger (GTU) Units
P/N 460T2300, 460T23.10, 460T23.20, and 460T41.00**

1.0 PURPOSE

The purpose of this document is to define the necessary steps to configure the above 3PCI GTU's.

2.0 SCOPE

These instructions apply to the 460T23.00, 460T23.10, 460T23.20 and 460T41.00.

3.0 RESPONSIBILITY

It is the responsibility of the heating and regulating final test technician to follow this procedure.

4.0 DEFINITIONS

- 4.1 H/R Product Line
- 4.2 3PCI GTU – Three Phase Cosine Intercept Gate Trigger Unit
- 4.3 RROCT – Remote Reset Over Current Trip
References Schematic GTU - 479149.ALL 479150.ALL
Assembly GTU – 460T23.ALL, 460T41.ALL

5.0 PROCEDURE

- 5.1 The above GTU's are initially tested at the PC Board testing department as a 480VAC, 3Ø, 50/60Hz, Standard one second ramp, RMS Voltage Regulator.
 - 5.1.1 Refer to the proper schematic and assembly drawings
- 5.2 Customer Specifications
 - 5.2.1 The GTU configuration is selected by the Customer Service order options program.

Line Voltage is selected by Customer Specifications
 The line voltage is selected by a wire connection on each of 3 transformers. The wire must be moved to the appropriate voltage tap and soldered.
 Seven jumpers are used to configure the GTU to Customer Specifications. All Jumpers are received in the "A" position from the PWBA Vendor.

Ramp Option

S	J1 – Ramp Adjustment	0.1 Second,	J1 Open	J2 - Pos "B"
F	1.0 Second, J1 Pos "A"		J2 - Pos "A"	
E	4.0 Seconds J1 Pos "B"		J2 - Pos "A"	
S,E	J2 – Integrator Speed	Pos "A",		
F		Pos "B"		
CR	J3 – J4 (CR) Current Regulation Gain Adj.	Pos "A", Pos "B"		
VR	J5 – Pos "A" (VR) Voltage Regulation	J3, J4 Pos "A"		
CR	Pos "B" (CR) Current Regulation	J3, J4 Pos "B"		

PR Pos "C" (PR) Power Regulation J3, J4 Pos "A"

RROCT J6 – Zero ohm resistor normally installed by PCB vendor
Zero ohm resistor removed for remote reset OCT when required

J7 – Normally in Pos "A"
"Open" will give a 10 times longer ramp speed on all selected ramp speeds.

5.3 Final Test

5.3.1 Once the above steps are completed, test the 3PCI GTU with the customer SCR panel assembly in accordance with PSI-Oxx Maxie testing procedure.

5.3.2 Add a label below the 460T41.00, 460T23.00 if the customer requires a P/N to reflect the old number. Since any of the new PWBA's can replace any old PWBA and are forward and backward compatible.

Draft Authorization for Sign-off

Originator	Consensus Member	Consensus Member
Consensus Member	Consensus Member	Consensus Member

The following three (3) charts document which trigger circuits we have made in the past.

Gate Trigger Circuit in a Stand-alone Frame (350-1200A)

REPLACED BY: 460T23.10 Non-UL/CSA
460T23.20 UL/CSA

Item No.	Part Number	Rev	Description	Ramp		Integrator		Curr Reg		Curr Reg		J5			RR OCT		J7	
				J1	J2	J3	J4	Vreg	CR	Ext. FB	J6	Open	Closed	10 x Ramp in "B" Position	"A"	B		
1	460C17.01	A	3PCI TRIGGER CKT 208V	X	X	X	X	X	X	X	X					X	X	
2	460C17.02	A	3PCI TRIGGER CKT 240V	X	X	X	X	X	X	X	X					X	X	
3	460C17.05	A	3PCI TRIGGER CKT 480V	X	X	X	X	X	X	X	X					X	X	
4	460C17.05R		3PCI TRIGGER CKT 480V	X	X	X	X	X	X	X	X					X	X	
5	460C17.05RT		3PCI TRIGGER CKT 480V	X	X	X	X	X	X	X	X					X	X	
6	460C17.05T	A	3PCI TRIGGER CKT 480V TESTED	X	X	X	X	X	X	X	X					X	X	
7	460C17.06	A	3PCI TRIGGER CKT 600V	X	X	X	X	X	X	X	X					X	X	
8	460C17.08	A	3PCI TRIGGER CKT 440V		X	X	X	X	X	X	X					X	X	
9	460C17.11	A	3PCI TRIGGER CKT 208V ER	X	X	X	X	X	X	X	X					X	X	
10	460C17.12	A	3PCI TRIGGER CKT 240V 4 SEC	X	X	X	X	X	X	X	X					X	X	
11	460C17.13		3PCI TRIGGER CKT 380V 4 SEC	X	X	X	X	X	X	X	X					X	X	
12	460C17.14		3PCI TRIGGER CKT 415V 4 SEC	X	X	X	X	X	X	X	X					X	X	
13	460C17.15		3PCI TRIGGER CKT 480V 4 SEC	X	X	X	X	X	X	X	X					X	X	
14	460C17.15R		3PCI TRIGGER CKT 480V 4 SEC	X	X	X	X	X	X	X	X					X	X	
1	460C17.15RT		3PCI TRIGGER CKT 480V 4 SEC	X	X	X	X	X	X	X	X					X	X	
2	460C17.15T		3PCI TRIGGER CKT 480V 4 SEC	X	X	X	X	X	X	X	X					X	X	
3	460C17.22	A	3PCI TRIGGER CKT 240V FAST R	X	X	X	X	X	X	X	X					X	X	
4	460C17.23	A	3PCI TRIGGER CKT 415V FAST RAM		X	X	X	X	X	X	X					X	X	
5	460C17.25	A	3PCI TRIGGER, 480V FAST RAMP		X	X	X	X	X	X	X					X	X	
6	460C17.25R		3PCI TRIGGER, 480V FAST RAMP		X	X	X	X	X	X	X					X	X	
7	460C17.25RT		3PCI TRIGGER, 480V FAST RAMP		X	X	X	X	X	X	X					X	X	
8	460C17.25T		3PCI TRIGGER, TESTED, 480V, FR		X	X	X	X	X	X	X					X	X	
9	460C17.36	A	3PCI TRIGGER CKT, 480V CUR REG	X	X	X	X	X	X	X	X					X	X	
10	460C17.37		3PCI TRIGGER CKT, 240V CUR REG	X	X	X	X	X	X	X	X					X	X	
11	460C17.37R		3PCI TRIGGER CKT, 240V CUR REG	X	X	X	X	X	X	X	X					X	X	
12	460C17.37RT		3PCI TRIGGER CKT, 240V CUR REG	X	X	X	X	X	X	X	X					X	X	
13	460C17.45	A	3PCI TRIGGER CKT 480V DC FB		X	X	X	X	X	X	X				X	X	X	
14	460C17.65	A	3PCI TRIGGER CKT 480V DC FB FR		X	X	X	X	X	X	X				X	X	X	
1	460C17.65R		3PCI TRIGGER CKT 480V DC FB FR		X	X	X	X	X	X	X				X	X	X	
2	460C17.65RT		3PCI TRIGGER CKT 480V DC FB FR		X	X	X	X	X	X	X				X	X	X	
3	460C17.65T		3PCI TRIG CKT, 480V, DCFB, TESTED		X	X	X	X	X	X	X				X	X	X	
4	460C17.73																	
5	460C17.74																	
6	460C17.75																	

Gate Trigger Only (350-1200A)

REPLACED BY: 460T23.00

Item No.	Part Number	Rev	Description	Ramp		Integrator		Curr Reg		Curr Reg		J5			RR OCT		J7	
				J1		J2		J3		J4		Vreg	CR	Ext. FB	J6		10 x Ramp in "B" Position	
				A	B	A	B	A	B	A	B	A	B	C	Open	Closed	"A"	B
1	460C33.01	M	ASSY GTU BRD 208V STD RAMP	X	X			X	X	X	X	X				X	X	
2	460C33.02	M	ASSY GTU BRD 240V STD RAMP	X	X			X	X	X	X	X				X	X	
3	460C33.04	M	GTU 380/415V STD RAMP	X	X			X	X	X	X	X				X	X	
4	460C33.05	M	ASSY GTU BRD 480V STD RAMP	X	X			X	X	X	X	X				X	X	
5	460C33.05R		ASSY GTU BRD 480V STD RAMP	X	X			X	X	X	X	X				X	X	
6	460C33.05RT		ASSY GTU BRD 480V STD RAMP	X	X			X	X	X	X	X				X	X	
7	460C33.06	M	ASSY GTU BRD 600V STD RAMP	X	X			X	X	X	X	X				X	X	
8	460C33.11	M	ASSY GTU BRD 208V LONG RAMP			X		X	X	X	X	X				X	X	
9	460C33.12	M	ASSY GTU BRD 240V LONG RAMP		X	X		X	X	X	X	X				X	X	
10	460C33.12T		ASSY GTU BRD 240V LONG RAMP		X	X		X	X	X	X	X				X	X	
11	460C33.13	M	ASSY GTU BRD 380V LONG RAMP		X	X		X	X	X	X	X				X	X	
12	460C33.14	M	ASSY GTU BRD 415V LONG RAMP		X	X		X	X	X	X	X				X	X	
13	460C33.15	M	ASSY GTU BRD 480V LONG RAMP		X	X		X	X	X	X	X				X	X	
14	460C33.17	M	ASSY GTU BRD 240V, 5-23 SEC		X	X		X	X	X	X	X				X	X	
1	460C33.17T	M	TESTED, GTU BRD, 240V, 5-23 SEC		X	X		X	X	X	X	X				X	X	
2	460C33.21	M	ASSY GTU BRD 208V FAST RAMP			X	X	X	X	X	X	X				X	X	
3	460C33.22	M	ASSY GTU BRD 240V FAST RAMP			X	X	X	X	X	X	X				X	X	
4	460C33.23	M	ASSY GTU BRD 380/415V FAST			X	X	X	X	X	X	X				X	X	
5	460C33.23T	M	ASSY GTU BRD 380/415V FAST			X	X	X	X	X	X	X				X	X	
6	460C33.25	M	ASSY GTU BRD 480V FAST RAMP			X	X	X	X	X	X	X				X	X	
7	460C33.25R		ASSY GTU BRD 480V FAST RAMP			X	X	X	X	X	X	X				X	X	
8	460C33.25RT		ASSY GTU BRD 480V PAST RAMP			X	X	X	X	X	X	X				X	X	
9	460C33.25T	M	ASSY GTU BRD, 480V, F.R. TESTED			X	X	X	X	X	X	X				X	X	
10	460C33.36	M	ASSY GTU 480V V/IREG STD RAMP	X	X					X	X	X	X			X	X	
11	460C33.37		ASSY GTU 240V V/IREG LONG RAMP		X	X		X	X	X	X	X				X	X	
12	460C33.41	M	GTU BRD 208V STD RAMP 10VDC FB	X				X	X	X	X	X			X	X	X	
13	460C33.42	M	GTU BRD 240V STD RAMP 10VDC FB	X	X			X	X	X	X	X			X	X	X	
14	460C33.44	M	GTU 380/415V STD RAMP 10VDC FB	X	X			X	X	X	X	X			X	X	X	
1	460C33.45	M	GTU BRD 480V STD RAMP 10VDC FB	X		X		X	X	X	X	X			X	X	X	
2	460C33.46	M	GTU BRD 600V STD RAMP 10VDC FB	X		X		X	X	X	X	X			X	X	X	
3	460C33.51	M	GTU BD 208V LONG RAMP 10VDC FB		X	X		X	X	X	X	X			X	X	X	
4	460C33.52	M	GTU BD 240V LONG RAMP 10VDC FB		X	X		X	X	X	X	X			X	X	X	
5	460C33.53	M	GTU BD 380V LONG RAMP 10VDC FB		X	X		X	X	X	X	X			X	X	X	
6	460C33.54	M	GTU BD 415V LONG RAMP 10VDC FB		X	X		X	X	X	X	X			X	X	X	
7	460C33.55	M	GTU BD 480V LONG RAMP 10VDC FB		X	X		X	X	X	X	X			X	X	X	
8	460C33.61	M	GTU BD 208V FAST RAMP 10VDC FB			X	X	X	X	X	X	X			X	X	X	
9	460C33.62	M	GTU BD 240V FAST RAMP 10VDC FB			X	X	X	X	X	X	X			X	X	X	
10	460C33.63	M	GTU BD 415V FAST RAMP 10VDC FB			X	X	X	X	X	X	X			X	X	X	
11	460C33.65	M	GTU BD 480V FAST RAMP 10VDC FB			X	X	X	X	X	X	X			X	X	X	
12	460C33.65T	M	TESTED GTU BRD 480V DCFB FAST			X	X	X	X	X	X	X			X	X	X	
13	460C33.73	A	ASSY GTU, 380/415V, 20T POT, FAST			X	X	X	X	X	X	X			X	X	X	
14	460C33.73T	A	GTU, TESTED, 380/415V, 20T POT			X	X	X	X	X	X	X			X	X	X	
1	460C33.74	A	ASSY GTU BRD 240V, 20T POT, FAST			X	X	X	X	X	X	X			X	X	X	
2	460C33.75	A	ASSY GTU BRD 480V, 20T POT, FAST			X	X	X	X	X	X	X			X	X	X	
3	460C33.X	M	COMMON PARTS GTU BRD (3PH)	X		X		X	X	X	X	X			X	X	X	

Gate Trigger Only (15-225amp)

REPLACED BY: 460T41.00

Item No.	Part Number	Rev	Description	Ramp		Integrator		Curr Reg		Curr Reg		J5			RR OCT		J7	
				J1		J2		J3		J4		Vreg	CR	Ext. FB	J6		10 x Ramp in "B" Position	
				A	B	A	B	A	B	A	B	A	B	C	Open	Closed	"A"	B
1	469196.01	U	ASSY GTU BRD 208V STD RAMP	X	X	X	X	X	X	X	X					X	X	
2	469196.02	U	ASSY GTU BRD 240V STD RAMP	X	X	X	X	X	X	X	X					X	X	
3	469196.02R		ASSY GTU BRD 240V STD RAMP	X	X	X	X	X	X	X	X					X	X	
4	469196.02RT		ASSY GTU BRD 240V STD RAMP	X	X	X	X	X	X	X	X					X	X	
5	469196.02T	U	ASSY GTU BRD 240V STD RAMP	X	X	X	X	X	X	X	X					X	X	
6	469196.03	U	ASSY GTU BRD 380V STD RAMP	X	X	X	X	X	X	X	X					X	X	
7	469196.04	U	GTU 380/415V STD RAMP	X	X	X	X	X	X	X	X					X	X	
8	469196.04T	U	GTU 380/415V STD RAMP	X	X	X	X	X	X	X	X					X	X	
9	469196.05	U	ASSY GTU BRD 480V STD RAMP	X	X	X	X	X	X	X	X					X	X	
10	469196.05RT		ASSY GTU BRD 480V STD RAMP	X	X	X	X	X	X	X	X					X	X	
11	469196.05T	U	TESTED GTU BRD 480V STD RAMP	X	X	X	X	X	X	X	X					X	X	
12	469196.06	U	ASSY GTU BRD 600V STD RAMP	X	X	X	X	X	X	X	X					X	X	
13	469196.11	U	ASSY GTU BRD 208V LONG RAMP		X	X	X	X	X	X	X					X	X	
14	469196.12	U	ASSY GTU BRD 240V LONG RAMP		X	X	X	X	X	X	X					X	X	
1	469196.12R		ASSY GTU BRD 240V LONG RAMP		X	X	X	X	X	X	X					X	X	
2	469196.12RT		ASSY GTU BRD 240V LONG RAMP		X	X	X	X	X	X	X					X	X	
3	469196.12T		ASSY GTU BRD 240V LONG RAMP		X	X	X	X	X	X	X					X	X	
4	469196.13	U	ASSY GTU BRD 380V LONG RAMP		X	X	X	X	X	X	X					X	X	
5	469196.14	U	ASSY GTU BRD 415V LONG RAMP		X	X	X	X	X	X	X					X	X	
6	469196.15	U	ASSY GTU BRD 480V LONG RAMP		X	X	X	X	X	X	X					X	X	
7	469196.15T		ASSY GTU BRD 480V LONG RAMP		X	X	X	X	X	X	X					X	X	
8	469196.16	U	ASSY GTU BRD 600V LONG RAMP		X	X	X	X	X	X	X					X	X	
9	169196.17	T	ASSY GTU BRD 240V, 5-23 SEC.		X	X	X	X	X	X	X					X	X	
10	469196.17T	T	TESTED, GTU BRD, 240V, 5-23 SEC.		X	X	X	X	X	X	X					X	X	
11	469196.21	U	ASSY GTU BRD 208V FAST RAMP			X	X	X	X	X	X					X	X	
12	469196.22	U	ASSY GTU BRD 240V FAST RAMP			X	X	X	X	X	X					X	X	
13	469196.23	U	ASSY GTU BRD 380/415V FAST			X	X	X	X	X	X					X	X	
14	469196.23T	U	ASSY GTU BRD 380/415V FAST			X	X	X	X	X	X					X	X	
1	469196.25	U	ASSY GTU BRD 480V FAST RAMP			X	X	X	X	X	X					X	X	
2	469196.25R		ASSY GTU BRD 480V FAST RAMP			X	X	X	X	X	X					X	X	
3	469196.25RT		ASSY GTU BRD 480V FAST RAMP			X	X	X	X	X	X					X	X	
4	469196.25T	U	TESTED ASSY GTU BRD 480V FAST			X	X	X	X	X	X					X	X	
5	469196.35	B	ASSY GTU BRD 480V STD RAMP.	X	X	X	X	X	X	X	X					X	X	
6	469196.36	T	ASSY GTU 480V VIREG STD RAMP	X	X			X		X		X				X	X	
7	469196.41	U	GTU BRD 208V STD RAMP 10VDC FB	X	X	X	X	X	X			X				X	X	
8	469196.42	U	GTU BRD 240V STD RAMP 10VDC FB	X	X	X	X	X	X			X				X	X	
9	469196.43	U	GTU BRD 380V STD RAMP 10VDC FB	X	X	X	X	X	X			X				X	X	
10	469196.44	U	GTU 380/415V STD RAMP 10VDC FB	X	X	X	X	X	X			X				X	X	
11	469196.45	U	GTU BRD 480V STD RAMP 10VDC FB	X	X	X	X	X	X			X				X	X	
12	469196.46	U	GTU BRD 600V STD RAMP 10VDC FB	X	X	X	X	X	X			X				X	X	
13	469196.51	U	GTU BD 208V LONG RAMP 10VDC FB		X	X	X	X	X			X				X	X	
14	469196.52	U	GTU BD 240V LONG RAMP 10VDC FB		X	X	X	X	X			X				X	X	
1	469196.53	U	GTU BD 380V LONG RAMP 10VDC FB		X	X	X	X	X			X				X	X	
2	469196.54	U	GTU BD 415V LONG RAMP 10VDC FB		X	X	X	X	X			X				X	X	
3	469196.55	U	GTU BD 480V LONG RAMP 10VDC FB		X	X	X	X	X			X				X	X	
4	469196.61	U	GTU BD 208V FAST RAMP 10VDC FB			X	X	X	X			X	X			X	X	
5	469196.62	U	GTU BD 240V FAST RAMP 10VDC FB			X	X	X	X			X	X			X	X	
6	469196.63	U	GTU BD 415V FAST RAMP 10VDC FB			X	X	X	X			X	X			X	X	
7	469196.65	U	GTU BD 480V FAST RAMP 10VDC FB			X	X	X	X			X	X			X	X	
8	469196.65R		GTU BD 480V FAST RAMP 10VDC FB			X	X	X	X			X	X			X	X	
9	469196.65RT		GTU BD 480V FAST RAMP 10VDC FB			X	X	X	X			X	X			X	X	
10	469196.73	A	ASSY GTU, 380/415V, 20T POT, FAST			X	X	X	X			X	X			X	X	
11	469196.73T	A	GTU, TESTED, 380/415V, 20T POT			X	X	X	X			X	X			X	X	
12	469196.74	A	ASSY GTU BRD 240V, 20T POT, FAST			X	X	X	X			X	X			X	X	
13	469196.75	A	ASSY GTU BRD 480V, 20T POT, FAST			X	X	X	X			X	X			X	X	
14	469196.95		ASSY GTU BRD 480V STD RAMP	X	X	X	X	X	X			X				X	X	
1	469196.95T		(TESTED) GTU BRD 480V STD RAMP	X	X	X	X	X	X			X				X	X	
2	469196.X	U	COMMON PARTS GTU BOARD (3PH)	X	X	X	X	X	X			X				X	X	

▽▽▽

INDEX

Note that locator page numbers appear in regular type faces for standard index references (e.g., 7-10). For index references that correspond to items found in tables, the locator page numbers are shown in an italic type face (e.g., 6-24). For index references that correspond to items found in figures and illustrations, the locator page numbers are shown in a boldface type face (e.g., **3-3**). Illustrations that appear in tables have locator page numbers that are both boldface and italic (e.g., **6-16**).

—Numbers—

3PCI power controller, **1-1**
50/60 Hz operation, 1-1

—A—

AC input, **2-2**
air flow, 2-1
ambient temperature, 5-4
 change, 1-4
 range, 1-4
analog voltmeter, 3-1, 3-2
auto/manual control with a controller and
 potentiometer, 3-1, 3-3
auto/manual control with controller and remote
 potentiometer, **3-3**
auto/manual switch, **3-3**
automatic operation, 3-2
automatic restart circuitry, 1-1

—B—

bias, 1-4, **2-2**, 3-1, 3-2, 4-1, 5-5
bias control, 1-2, 4-1
branch circuit overcurrent protection, 2-2

—C—

calibration, 3-2, 3-3, 3-4, 4-1
CID option, 1-5
circuit breaker, 3-1, 3-2, 3-3, 5-1
circuit protection, 1-2
conductor size, 2-2
connections
 operating with an adequate load, 3-1, 5-1
contamination, 5-4
control circuit, 1-2
control methods, 1-2, 1-4, 3-1
control setting, 1-3, 5-5
control signal, 1-1, 1-3, 2-4, 3-2, 4-1, 5-1
 input impedance, 1-4
 isolation, 1-4
controller output, 1-3, 3-2
controlling several 3PCIs connected in parallel,
 3-1, 3-4
cooling fans, 2-1
corrosion, 5-5

cosine intercept, 1-1
current, 1-5
current adjust, **2-2**
current imbalance detection, 1-5
current level, 1-2, 1-3, 4-1
 maintaining a constant, 1-3
current limit, 1-3, 1-4, 4-1
current limit control setting, 1-3
current ratings, 1-4, 1-5, 2-1, 2-2
current regulation, 1-3, 1-5
 range, 1-3
current transformer, 1-2, 1-3, **2-2**

—D—

digital firing control circuit, 1-2
dimensions, **1-2**, 6-4
drawing list, 6-4
dry contact closure, 1-4

—E—

electrical hazards, 3-3, 5-1
electronic fuse, 1-2
electrostatic discharge, 2-1, 5-1, 5-4
electrostatic discharge precautions, 5-4
e-mail, 6-1
environmental issues, 5-4
ESD protection, 2-1
excessive vibration, 5-4, 5-5
extended ramp, 1-3
external control methods, 1-2
external controller signal, 3-1
external feedback, 2-3

—F—

fan cooling power, 1-4
fan wiring, 2-1
fan-cooled models, 2-1
fast-gate shutdown, 1-2
fax, 6-1
features, 1-1
feedback signal, 1-3
firing control, 5-5
firing control circuit, 1-2
frequency, 1-4
full output unaffected by control signal change,
 5-1

fused disconnect, 3-1, 3-2, 3-3, 5-1
 fuses, 5-5, 5-6
 manufacturers and p, 5-6
 replacement, 5-6

—G—

gain control, 1-2, 1-4, **2-2**, 3-1, 3-2, 4-1, 5-5
 galvanic isolation, 1-4
 gating, 1-2
 ground, 2-3

—H—

hard-gate firing, 1-1
 heat sink, 2-1, 3-3, 5-1, 5-4, 5-5
 heat sink fins, 2-1
 heat sink temperature, 2-1
 heat sink thermostats, 2-1
 high ambient temperature, 5-4

—I—

inadequate cooling, 5-4
 input and output connections overview, **2-3**
 input impedance, 1-4, 3-1, 3-2
 input isolation from ground, 1-1
 input line voltage, 1-4
 input lines, clearance, 2-1
 input power and load connections, 5-5
 input signals, 1-1, 1-4
 input type, 1-5
 input/output wiring, 2-1
 installation, 2-1
 instantaneous peak current, 1-2
 insulation, 5-5
 internal 3PCI connections, 2-4
 internal manual control of power output, 3-1
 isolated inputs, **3-2**

—J—

jumper J2, 4-1

—L—

line connections, 2-1, **2-2**
 line current, 1-3
 line frequency, 1-2, 1-4
 synchronization, 1-1
 line voltage, 1-1, 1-4, 3-1, 5-1
 turn on, 2-1
 linearity, 1-4
 load, **2-2**
 changes, 1-3
 connections, 2-1, **2-2**, 5-1

 operating with an adequate load, 3-1, 5-1
 current, 1-2
 lug kit, 1-5

—M—

maintenance, 3-1, 5-4
 manual control, 1-2, 3-1, 5-5
 manual pot, **3-2**, **3-3**
 maximum power demand, 3-3, 3-4
 metal oxide varistor (MOV), 1-4
 model number, 1-4, 1-5, 6-1
 code descriptions, 1-5
 mounting hole requirements, 2-1

—N—

no output, 5-1
 normally-closed contacts, 2-1
 normally-open contacts, 2-1

—O—

on/off control, 3-1, 3-3
 output disabled by contact closure, 3-3, **3-4**
 output enabled by contact closure, **3-3**
 open SCR fuse, 5-5
 operation, 1-2, 3-1
 using an adequate load, 3-1, 5-1
 option CL, 1-3, 4-1
 option CR, 1-3
 option ER, 1-3
 option OC, 1-2
 options, 1-3, 1-5, 4-1
 out-of-phase condition, 2-2
 output, 1-1, 1-2, 1-3, 1-4, 3-1, 3-2, 3-3, 3-4, 4-1,
 5-1, 5-5, 5-6
 output current overloads, 1-2
 output lines, clearance, 2-1
 output terminals, 3-1
 output voltage, 1-1, 3-1, 3-2, 5-1
 change, 1-4
 range, 3-2
 regulation, 1-1

—P—

parallel connection of several 3PCIs, **3-4**
 phase-firing time base, 1-4
 phase-rotation insensitivity, 2-2
 phone, 6-1
 PIV rating, 1-4
 pot input, 1-4, 1-5
 potentiometer, 1-4, **3-2**, 3-3
 ratings, 3-2
 power control, 1-1, 1-2, 1-3

power output, 1-4
 power regulation, 1-5
 power SCRs protection, 1-4
 preset maximum current level, 1-3
 process control signal, 1-3
 process controller, 1-4
 protection, 1-2, 1-4, 2-1, 2-2

—R—

ramp rate, 1-5
 RC snubber, 1-4
 remote control with a potentiometer, 3-2
 remote manual control (only) with a potentiometer, 3-1, 3-2
 remote panel, 3-2
 replacement fuses, 5-6
 reset push-button, 1-2, 4-1
 resistive and inductive loads, 1-1
 rms current, limiting, 1-3

—S—

SCR firing disturbances, 1-1
 SCR network shorted, 5-5
 SCR protection, 2-1
 SCRs are not firing, 5-5
 service, 6-1
 setup, 3-1, 4-1
 shutdown, 2-3
 sizes for conductors, 2-2
 soft-start, 1-1
 source types, 3-1
 spare parts, 6-1
 specifications, 1-3, 1-4, 2-2, 5-6, 5-7
 static-free packing materials, 2-1
 switching, 1-2, 3-3, 4-1
 synchronization of line frequency, 1-1

—T—

technical specifications, 1-4
 temperature, 5-4
 temperature control calibration, 3-2
 temperature controller, 1-4, 3-1, 3-2
 terminal block specifications, 2-3
 terminals, 1-2, 2-1, 2-2, 3-1, 3-2, 3-4, 4-1, 5-5
 thermostat contact rating, 1-4
 thermostats, 2-1
 three-phase current limit, 1-3
 three-phase current regulation, 1-3
 three-phase overcurrent trip, 1-2
 torque specifications, 2-2, 5-6, 5-7
 transient voltage spikes (dV/dt), 1-4
 trip point, 1-2
 trip relay contacts, 1-2, 4-1

trip reset push-button, 1-2
 troubleshooting, 5-1
 symptoms and solutions, 5-5

—V—

vibration, 5-5
 voltage, 1-5
 input, 2-3
 regulation, 1-4

—W—

weight, 1-4
 wire size information, 2-2
 wiring overtemperature contacts, 2-1

—Z—

zero output, 3-1, 3-2
 zero power demand, 3-3, 3-4

▽ ▽ ▽

