

## SPT-90

### OPERATING INSTRUCTIONS

• General features _____	2
• Technical features _____	2
• Installation _____	5
• Preliminary operations _____	7
• Front panel description _____	8
• Operating mode _____	9
• Accuracy information _____	19
• <b>Useful information</b> _____	22
• Appendix _____	25

#### **Important:**

We suggest you keep the original packing in case it is necessary to return the instrument to our Technical Service Department.

In order to achieve the most from your instrument, we recommend you read this instruction manual carefully.

**CARLO GAVAZZI Instruments**

**SPT-90**

**16-bit  $\mu$ P-based modular smart power transducer**

rev. 1

**Operating instructions**

**Important:**

We suggest you keep the original packing for a further shipping of the instrument.

In order to guarantee a correct use of the transducer, we recommend the user to carefully read the present instruction manual.

---

## **GENERAL FEATURES**

---

**The most important features are:**

- Only two basic models
- TRMS measurements
- 5 input ranges
- Connections to CT and VT, full range CT and VT ratio programming
- Measurements of W, Wavg (programmable from 1 to 30 minutes), VA, var, (power factor)  $\cos\phi$ , Wh, VAh, varh, Amax (among the phases), Vdelta avg, VL1-N, VL2-N, VL3-N, Hz L1
- Outputs: 20mA,  $\pm 5$ mA,  $\pm 10$ mA,  $\pm 20$ mA, 10V,  $\pm 1$ V,  $\pm 5$ V,  $\pm 10$ V (all with scaling), DC pulse (programmable pulse for kWh, KVAh, kvarh), serial RS485 (MODBUS/JBUS), RS232 and alarm set-point.

**The main programming parameters are:**

- Programming of the password
- Selection of the electrical system
- Programming of CT and VT ratio
- Programming of analogue and serial outputs (when present)
- Selection of energy measurement (if the pulse output is available)
- Programming of the output working
- Programming of the digital filter
- Programming of the power integration time (Wavg).

---

## **TECHNICAL FEATURES**

---

**BASIC ACCURACY (VOLTAGE/CURRENT):** 0.5% F.S.

**BASIC ACCURACY (POWER/ENERGY):** 0.5% F.S.

**TEMPERATURE DRIFT:** analogue output: 300ppm/ $^{\circ}$ C  
serial output: 200ppm/ $^{\circ}$ C

**RIPPLE:**  $\leq 1\%$

**RESPONSE TIME:**  $\leq 250$ ms typical

**5 INPUT RANGES:** 100/√3 / 100VAC - 1AAC (AV1)  
 100/√3 / 100VAC - 5AAC (AV3)  
 250 / 433 VAC - 1AAC (AV4)  
 250 / 433 VAC - 5AAC (AV5)  
 400 / 690 VAC - 5AAC (AV7)

**FREQUENCY RANGE:** From 48 to 62 Hz

**OVERLOAD PROTECTION:** continuous: 1.2 Un/In,  
 for 1 second: 20 In, 2 Un

**TRMS MEASUREMENT:** direct coupling, crest factor 3

**SAMPLING FREQUENCY:** 1900 Hz

**ALARM SET-POINT (IF AVAILABLE):** 1 adjustable set-point alarm.

Alarm type: high alarm, low alarm. Programmable hysteresis and time delay. The control can be connected to the following: W, VA, var, Wavg and PF (cosφ) system, maximum current (among the phases), V delta avg, VL1-N, VL2-N, VL3-N, Hz L1;

Time delay activation: programmable from 0 to 255 seconds;

Output status: normally de-energized;

Output type: relay, SPDT

AC 1 - 8A@250VAC

DC 12 - 5A@24VDC

AC 15 - 2.5A@250VAC

DC 13 - 2.5A@24VDC

Maximum response time: 250 ms (filter excluded, set-point activation time delay: "0");

Insulation: 4000VRMS between output and power supply input; 4000VRMS between output and power supply input.

**FILTER:** operating range: from 0 to 99.9% of the input scale both on the analogue and the serial output (action on the fundamental variables: V/A/W and relevant derivatives); filtering coefficient: from 1 to 255.

**ANALOGUE OUTPUT:** from 0 to 20mADC,  $\pm 5$ mADC,  $\pm 10$ mADC,  $\pm 20$ mADC, from 0 to 10 VDC,  $\pm 1$ VDC,  $\pm 5$ VDC,  $\pm 10$ VDC with zero and full scale programming within the whole range. With filter action.

Load: output 20mA:  $\leq 600 \Omega$

output  $\pm 20$ mA:  $\leq 550 \Omega$

output  $\pm 10$ mA:  $\leq 1100 \Omega$

output  $\pm 5$ mA:  $\leq 2200 \Omega$

Load: output 10V:  $\geq 10 \text{ k}\Omega$

output  $\pm 10$ V:  $\geq 10 \text{ k}\Omega$

output  $\pm 5$ V:  $\geq 10 \text{ k}\Omega$

output  $\pm 1$ V:  $\geq 10 \text{ k}\Omega$

Insulation: by means of optocouplers, 4000VRMS between output and measuring inputs; 4000VRMS between output and power supply input.

Accuracy: 0.2% f.s.

**PULSE OUTPUT (IF AVAILABLE):** output type: open collector (transistor

NPN),  $V_{ON}$  1.2VDC/max.100mA;  $V_{OFF}$  30VDC max. according to DIN43864; pulse duration: 20ms (ON), 20ms (OFF); insulation: by means of optocouplers, 4000VRMS between output and measuring inputs, 4000VRMS between output and power supply input.

**RS485/RS422 SERIAL OUTPUT (IF AVAILABLE):** multidrop: bidirectional (static and dynamic variables); 2 or 4 wires; maximum distance 1200m; termination and/or line bias selectable directly by dip-switch; 255 programmable addresses; data format: 1 start bit, 8 data bits, no parity / even parity, 1 stop bit; baud rate: 1200, 2400, 4800 and 9600 baud selectable by key-pad; protocol according to the MDOBUS/JBUS.

Reading of single phase variables:

P,  $P_{AVG}$ , S, Q, PF ( $\cos\phi$ ),  $V_{L-L}$ , f, energy and status of digital inputs, set-point output and status of the energy overflow bit, transducer's model.

Reading of single phase variables:

$P_{L1}$ ,  $S_{L1}$ ,  $Q_{L1}$ , PF ( $\cos\phi$ ) $_{L1}$ ,  $V_{L1-N}$ ,  $I_{L1}$

$P_{L2}$ ,  $S_{L2}$ ,  $Q_{L2}$ , PF ( $\cos\phi$ ) $_{L2}$ ,  $V_{L2-N}$ ,  $I_{L2}$

$P_{L3}$ ,  $S_{L3}$ ,  $Q_{L3}$ , PF ( $\cos\phi$ ) $_{L3}$ ,  $V_{L3-N}$ ,  $I_{L3}$

Writing: all programming parameters, reset of the energy overflow bit, reset of energy totalization, activation of static output.

Stored energy (EEPROM): 250.000.000 kWh

Insulation: by means of optocouplers, 4000VRMS between output and measuring inputs, 4000 VRMS between output and power supply input.

Temperature drift: 200 ppm/°C

**RS232 SERIAL OUTPUT (IF AVAILABLE):** bidirectional (static and dynamic variables); 3 wires; maximum distance 15m; data format: 1 start bit, 8 data bit, no parity, 1 stop bit; baud rate: 9600 baud; protocol according to MODBUS/JBUS.

Other specifications: same as RS485/RS422

#### **POWER SUPPLY INPUT**

From 90 to 260VAC/VDC, 50/60 Hz;

From 18 to 60VAC/VDC, 50/60 Hz;

Self-consumption:  $\leq 30VA / 20W$  (from 90 to 260V)  
 $\leq 20VA / 20W$  (from 18 to 60V)

**OPERATING TEMPERATURE:** from 0 to +50°C (R.H. < 90% non-condensing)

**STORAGE TEMPERATURE:** from -10 to +60°C (R.H. < 90% non-condensing)

**REFERENCE VOLTAGE FOR THE INSULATION:** 300VRMS to earth

**INSULATION:** 4000VRMS between all outputs/inputs to ground

**DIELECTRIC STRENGTH:** 4000VRMS for 1 minute

**NOISE REJECTION (CMRR):** 100 dB, from 48 to 62 Hz

**ACCORDING TO THE FOLLOWING STANDARDS:**

Electromagnetic compatibility: **EN 50 081-2, EN 50 082-2**

Safety: IEC 61010-1, EN 61010-1

Product: IEC 60688-1, EN 60688-1

Pulse output: DIN 43864

**CONNECTIONS:** screw-type. Max. 2.5 mm<sup>2</sup> wire (x2)

**DIMENSIONS:** 90 x 90 x 140 mm

**MATERIAL:** ABS, self-extinguishing: UL 94 V-0.

**PROTECTION DEGREE:** IP 20

**WEIGHT:** 550 g. approx. (packing included).

---

## INSTALLATION

---

### Overall dimensions and panel cutout

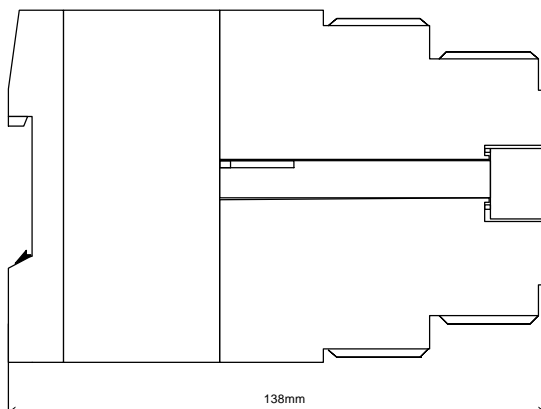
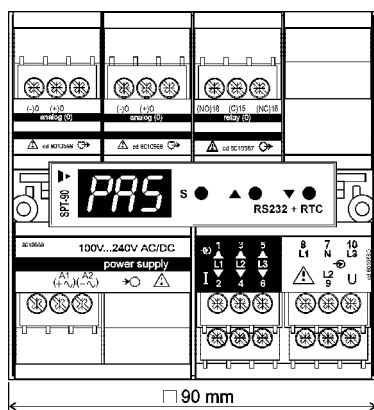

### Mounting

The instrument is to be mounted on DIN-rail.

### Connections

See the wiring diagrams on the appendix.

Position of the slots and relevant modules

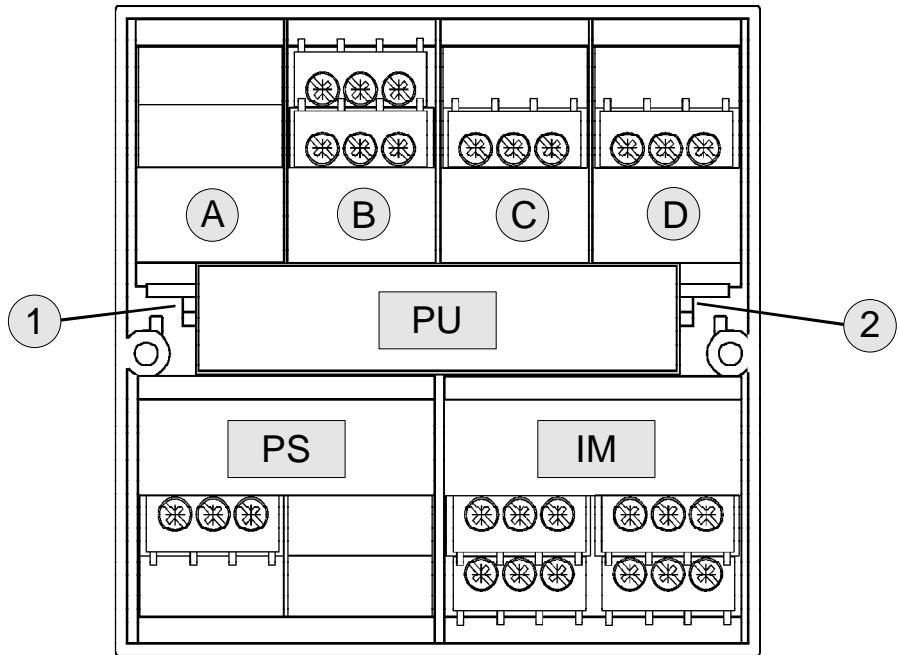

DESCRIPTION	A	B	C	D	PU	PS	I M
Single analogue output	•	•					
Dual analogue output	•	•					
RS485 serial output		•					
RS232 serial output					•		
Programming module					•		
Single relay output			•	•			
Dual output			•	•			
Single relay output			•	•			
Dual relay output			•	•			
Digital inputs			•				
Power supply						•	
Measuring inputs							•

---

## PRELIMINARY OPERATIONS

---

Before supplying the instrument, make sure that the power supply voltage corresponds to what is indicated on the lateral label of the relevant module.  
For example:

### AP1020

Universal power supply

100V...240V DC/AC (50Hz to 60Hz)

input range

12W / 30VA 1 PHASE

power consumption

S/N 001900/20115

serial number

**WARNING:** the measuring input module is fixed and sealed to the main unit of the instrument. Its removal implies the breakage of the seal with subsequent expiry of the warranty.

The various modules (input, output and power supply) have been conceived to be mounted only in one of all the slots available.

To know in which slot every module is to be mounted, refer to the drawing on the previous page.

For a correct mounting of the instrument, insert the modules in the relevant slots, then, at the end, enter the central module, which is a blind module or a programming key-pad or a communication port RS232 and will fix the other modules in the relevant slots. To remove the modules, use a screwdriver:

A) lever the two fixing tabs (points "1" and "4" in the drawing below)

B) extract the central module,

C) remove also the other modules.

NOTE: any slot which has not been used must be closed by means of the special plug modules.

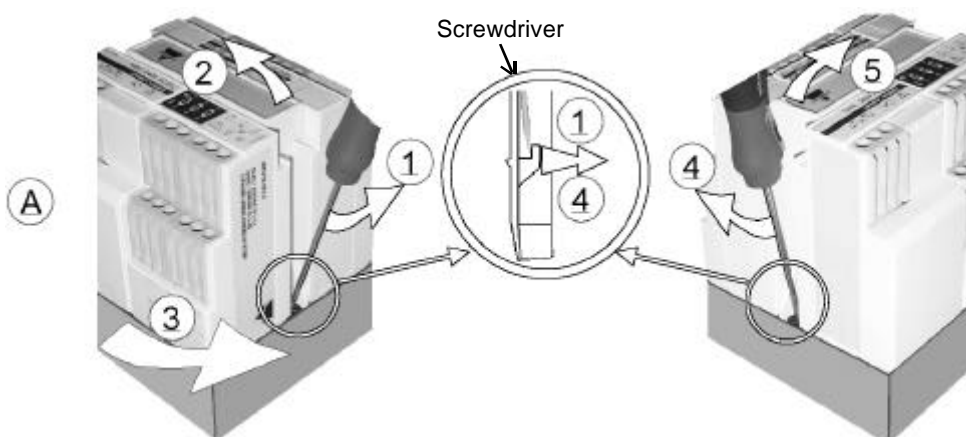

## FRONT PANEL DESCRIPTION

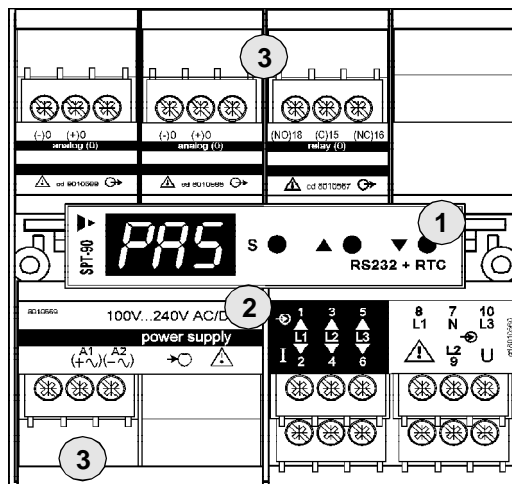

Note: the keyboard + display module for parameter programming may not be present on the instrument: in this case, the RS232 serial output module or a plug module (without any function) can take its place.

### 1. Keyboard

The keyboard module (when present) allows to access to the following functions:

#### **Functions available out of the programming phase.**

##### **Keys to be pressed:**

- ▼ ● Displaying of the revision number (example: r. 0), for a few seconds.
- s ● For more than two seconds: access to the programming phase.

#### **Functions available in the programming phase.**

##### **Keys to be pressed:**

- s ● Password confirmation.

Access to the main menu and to the secondary menus;

In the secondary menus: value setting and exit from the secondary menu.

▲ ● Increase of the password value.

In the main menu: selection of the parameters (from the first to the last).

In the secondary menus: increase of the displayed value.

▼ ● Decrease of the password value.

In the main menu: selection of the parameters (from the last to the first).

In the secondary menus: decrease of the displayed value

### 2. Display

Alphanumeric indication by means of a 7-segment LED:

- of the programming parameters;
- of the alarm status.

### 3. Terminal blocks



---

## OPERATING MODE

---

It is possible to configure SPT-90 either by means of a special configuration software "SptSoft" or by means of a special programming module:

### • Displaying and control (if the programming module is present)

During the operating phase, the following status indications may be displayed:



• the decimal point of the digit on the right is blinking: the transducer works regularly and it's not in alarm status;



• the upper segments of the 3 digits are blinking: the operator has set a high alarm set-point and the instrument is in alarm status;



• the lower segments of the 3 digits are blinking: the operator has set a low alarm set-point and the instrument is in alarm status.



• the central segments of the 3 digits are blinking; the static output has been activated by means of the serial interface.

### • Programming

To enter the programming phase, press the **S** key until "**PAS**" is shown on the display; then "**0**" will be displayed: the correct numerical code (password) is to be selected now. The following conditions may occur:

- 1) the operator hasn't entered any password: press the **S** key to enter the configuration menu of the transducer;
- 2) the operator has already entered a Password: select the correct password by means of the **▲** key (to increase the displayed value) or **▼** (to decrease it) until the desired value is displayed.

Press the **S** key to confirm the value; if the password is correct, then the display will show "**P.CH**" that is the first configuration menu; if the password is not correct, the display shows "**End**" and the transducer goes back to the displaying and control phase.

PROGRAMMING OF A NEW PASSWORD AND AUTOMATIC SELECTION OF THE PROTECTION LEVEL OF THE CONFIGURATION DATA.

To enter the new Password:

- if the Password is "**0**", when the display shows the "**P.CH**" message, followed by "**oLd**" and then "**0**", select the desired numerical code using the **▲** or **▼** keys, then confirm it by pressing the **S** key: the display will show the first configuration menu "**P.CH**".
- if the Password has already been entered, it is possible to modify it following the procedure described at No. 2); after the "**P.CH**" message, the display shows "**oLd**" followed by the already programmed value; select the new numerical code using the **▲** or **▼** keys and confirm it by pressing the **S** key: the display will show the first configuration menu "**P.CH**".

Data protection levels:

- if the Password is "**0**", the configuration data are not protected by undesired accesses;

- if the Password is a number between "1 and 499", the configuration data are almost entirely protected against undesired accesses.

It is possible to reset the Password by entering the number 682.

- **All programming/configuration steps of the transducer are shown in the flow chart in the centre of this manual. The flowchart has been conceived to make the operator better understand the programming structure of the transducer indicating the position of the current function with regards to the others. The flow chart also makes the commands to be used in the configuration phase more easily understandable.**
- **See the chapter "Front Panel Description" for all information regarding the use of the key-pad and the relevant main functions.**
- **Description and use of the displayed symbols:**  
(the symbols like **PAS** in a black background belong to the main menu; the symbols like **P-S** in a white background belong to the secondary menu).

**PAS** : access password to programming.

Programmable value:  $0 \leq \text{PAS} \leq 499$ .

**P.CH** : selection menu to modify the password

Programmable value:  $0 \leq \text{oLd} \leq 499$ .

**SYS** : selection menu of the electrical system (active only if the transducer takes measurements on single phase or three-phase systems with balanced load). Programmable value:

Selection	System type
1 P	Single phase
3 P	Three-phase, balanced load

**in.C** : selection menu of the current input/s.

**P-S** : programming of the (primary/secondary) current transformer/s ratio.

Programmable value:  $1 \leq \text{P-S} \leq 999$ .

Example: a CT with a 100A primary and a 5A secondary (100/5A) means a ratio (P-S value) equal to 20.

**in.U** : selection menu of the voltage input/s.

**d.P** : selection of the decimal point position when considering the voltage transformer/s (V.T.) ratio.

decimal Point Selection	Min. value	Max. value
111	1	999
11.1	0.1	99.9
1.11	0.01	9.99

**P-S**: programming of the (primary/secondary) voltage transformer (V.T.) ratio.

Programmable value:  $1 \leq P-S \leq 999$

Example: a V.T. with a 660V primary and a 100V secondary (660/100V) means a ratio (P-S value) of 6.6. The position of the decimal point has been previously selected as 11.1 to perform a V.T. ratio from 0.1 to 99.9.

**Ao.0**: selection menu of the digital output.

**rEt**: selection of the measurement to be retransmitted:

Selection	Measurement
r1	System's active power (W)
r2	System's apparent power (VA)
r3	System's reactive power (VAr)
r4	Average active power (Wavg)
r5	System's power factor (cosφ)
r6	Maximum current (A max.)
r7	Average phase-phase voltage
r8	Phase-neutral voltage-phase 1
r9	Phase-neutral voltage-phase 2
r10	Phase-neutral voltage-phase 3
r11	Frequency-phase 1

**Lo.A**: programming of the minimum electrical scale of the analogue output. Value to be expressed as % of the output range (20mA, ±20mA, ±10mA, ±5mA, 10V, ±10V, ±5V, ±1V) to be generated in correspondence with the minimum measured value (Lo.E parameter). Value programmable within the range:

$0.0 \leq Lo.A \leq 99.9$ .

Example: (0/20mA output) "Lo.E" = 0kW that must correspond to an output signal of 4mA.

$$\text{"Lo.A" (\%)} = \frac{100 \times ?mA}{20}$$

that in our example corresponds to  $100 \times 4mA / 20 = 20\%$ ; then enter 20.0.

Example: (0/10V output) "Lo.E" = 0kW that must correspond to a retransmitted signal of 1V.

$$\text{"Lo.A" (\%)} = \frac{100 \times ?V}{10}$$

that in our example corresponds to:  $100 \times 1V / 10 = 10\%$ ; then enter 10.0.

Example: (±10V output) "Lo.E" = -100kW that must correspond to a retransmitted signal of -10V.

$$\text{"Lo.A" (\%)} = 0$$

that in our example corresponds to an output of -10V when we have the minimum of the range as electrical input.

**Hi.A**: programming of the maximum electrical scale of the analogue output.

Value expressed as % of the output range (20mA,  $\pm 20$ mA,  $\pm 10$ mA,  $\pm 5$ mA, 10V,  $\pm 10$ V,  $\pm 5$ V,  $\pm 1$ V) to be generated in correspondence with the maximum measured value (Hi.E parameter). Value to be programmed within the range:  $0.0 \leq \text{Hi.A} \leq 99.9$ .

Example: (0/20mA output) "Hi.E" = 100kW that must correspond to a retransmitted signal of 18mA.

$$\text{"Hi.A" (\%)} = \frac{100 \times \text{mA}}{20}$$

that in our example corresponds to:  $100 \times 18\text{mA} / 20 = 90\%$ ; then enter 90.0.

Example (0/10V output): "Hi.E" = 100kW that must correspond to a retransmitted signal of 5V.

$$\text{"Hi.A" (\%)} = \frac{100 \times \text{V}}{10}$$

that in our example corresponds to:  $100 \times 5\text{V} / 10 = 50\%$ ; then enter 50.0. Also in this case it is possible to invert the scale, that is, a decreasing value of the retransmitted signal may correspond to an increasing value of the input variable.

Example ( $\pm 10$ V output): "Hi.E" = 100kW that must correspond to a retransmitted signal of 5V.

$$\text{"Hi.A" (\%)} = 100 - \frac{100 \times 5\text{V}}{20}$$

that in our example corresponds to:  $100 - (100 \times 5\text{V} / 20) = 75\%$ ; then enter 75.0

**Lo.E**: programming of the minimum electrical scale of the measurement (Lo.E is connected to the output value Lo.A). This value is preceded by a symbol indicating the multiplier of the measured parameter. The multiplier's symbol corresponds to the values indicated in the following table:

Symbol	Multiplier
none	1
<b>K</b>	1000
<b>M</b>	1000000

Moreover, the display will show the decimal point corresponding to the full scale. As a result, the programmable value, excluding the decimal point, will be as follows:  $-999 \leq \text{Lo.E} \leq 999$ .

**Note.** Should one or more of the preceding retransmitted measurements have been modified, then the displayed value will be "000", otherwise the

display will show the value set during the last programming.

At the first switching on, the value of "Lo.E" is automatically set to "0" by the transducer. This value can be changed in order to have a different beginning of scale corresponding to the "Lo.A" analogue output.

**Hi.E**: programming of the max. electrical scale of the measurement (Hi.E is connected to the Hi.A output value). This value is preceded by the same symbol indicating the multiplier of the measured variable as per "Lo.E"; also the decimal point is the same as per "Lo.E".

The value of "Hi.E" is to be higher than "Lo.E" of at least 50 digits. Programmable value:  $Lo.E + 50 \leq Hi.E \leq 999$ .

"Hi.E" is normally calculated by the transducer in accordance with both CT and VT ratios (see table below). If necessary, this parameter can be changed in order to have a lower/higher full scale corresponding to the "Hi.A" of the analogue output.

**Note.** Should one or more of the preceding values (that is CT ratio, VT ratio, selection of the measurement, Lo.A, Hi.A) have been modified, then the displayed value will be calculated according to the full scale of the transducer multiplied by the CT and VT ratios; if none of the previous variables has been modified, then the display will show the previously

VARIABLE	Standard HiE
r1 - System's active power (W)	$HiE = V_{L-N} * VT * Dp * I_N * CT * PH$
r2 - System's apparent power (VA)	$HiE = V_{L-N} * VT * Dp * I_N * CT * PH$
r3 - System's reactive power (var)	$HiE = V_{L-N} * VT * Dp * I_N * CT * PH$
r4 - Average active power (Wavg)	$HiE = V_{L-N} * VT * Dp * I_N * CT * PH$
r5 - System's power factor	$HiE = L.00$
r6 - Maximum current	$HiE = I_N * CT$
r7 - Phase-phase average voltage	$HiE = V_{L-L} * 3 * VT * Dp$
r8 - Phase-neutral voltage phase 1	$HiE = V_{L1-N} * VT * Dp$
r9 - Phase-neutral voltage phase 2	$HiE = V_{L2-N} * VT * Dp$
r10 - Phase-neutral voltage phase 3	$HiE = V_{L3-N} * VT * Dp$
r11 - Frequency phase 1	$HiE = 100$

$I_N$  = rated current

PH = number of phases

DP = multiplying value of the decimal point (1, 10 or 100)

programmed value.

**Example 1:** the transducer is a three-phase model for unbalanced loads and requires a rated input of a 100/√3 3V phase-neutral voltage and 5A current (AV3.3 model). The mains is 20,000V phase-phase voltage and the maximum current for each phase is 500A. Therefore, the relevant parameters become:

in.C → P-S = 100;

in.V → d.P = 111 (no decimal point) → P-S = 200.

The analogue output "OUTPUT 1" is a 4-20 mA (Lo.A = 20.0%, Hi.A = 99.9%) and the selected retransmitted measure is "r1" (system's active power). The automatic calculation of the full scale made by the transducer is  $20,000 / \sqrt{3} \times 500 \times 3 = 17.3\text{MW}$  ( $V\sqrt{3} / \sqrt{3} \times I \text{ max.} \times N^\circ$  of phases).

Prior to the setting of "Lo.E", the display will show the segment close to "M" (mega), which will be blinking, followed by 00.0. The same segment will appear for "Hi.E" followed by 17.3 (full scale value). The analogue output value will be 4mA when the power is equal to 0 and 20mA when the power is 17.3 MW.

**Example 2:** The mains is 10kV phase-phase voltage. With the same procedure described in example 1, select the "r7" measurement (average phase-phase voltage). The "Lo.A" value will be set at 80.0 (80% of the output full scale = 16mA) and the "Hi.A" value at 20.0 (20% of the full scale = 4mA). Prior to "Lo.E" and "Hi.E", the display shows the "-" on the right (indicating K) that will be flashing and the "00.0 and 10.0" values respectively will be set. In this case the value of the analogue output will be 4mA with a 10kV input, and 16mA with an input voltage equal to 0 (scale inversion).

**Note:** retransmission of the measured system's power factor ( $\cos\phi$ ). If the "r5" measurement is selected, the electrical parameters "Lo.E" and "Hi.E" display the type of power factor displacement which has been set ("C" capacitive or "L" inductive) followed by the decimal point and by the first two decimal numbers of the power factor.

Example: C.21 stands for a capacitive power factor the value of which is 0.21 and L.73 stands for an inductive power factor the value of which is 0.73. The only exception is the unit power factor which will be displayed as "1.00".

**A.o1:** selection menu of the additional analogue output (if available).

The programming steps are the same as those relating to output 0 "Ao.0".

**S.ou:** selection menu of the serial communication output (if available).

The transducer is provided with a serial interface (on request) that allows the communication with a PC or a PLC. It is possible to retransmit both the static and the dynamic variables and to make connections with more than one transducer (multidrop).

**Add**: programmable address value:  $1 \leq \text{Add} \leq 255$ .

**b.dr**: programming of the data baud rate:

Selection	Value
9.6_	9600 bit/s
4.8_	4800 bit/s
2.4_	2400 bit/s
1.2_	1200 bit/s

**PAR**: programming of the parity bit.

Selection	Parity
no	No parity
EUE	Even parity

For any further information on the serial interface, see the relevant literature (available on request).

**out**: selection menu of the output working (available only if the open collector/relay output is present). Set the working of the output in accordance with the following selections:

Selection	Output working
Loc	Local (to be used only as set-point/pulse output)
rEn	Remote (can be driven only by serial port)

**EnE**: selection menu of the energy measurement (selectable only if the serial output or the pulse output are present, and "out" has been selected locally). Programmable values:

Selection	Energy
E 1	Active energy (Wh). The negative energy is not added.
E 2	Apparent energy (VAh)
E 3	Reactive energy (VARh)
E 4	Active energy (Wh). The negative energy is added with its own sign.

The sign of active energy depends on the direction of the current: positive if it is a consumed energy; negative if it is a supplied energy. The reactive energy and the apparent energy are always positive.

**out**: selection menu of the output working (selectable only if the static output is present). The static output must be configured locally in the "S.ou" menu, otherwise the instrument ignores all the previously set

parameters and the output is activated and deactivated only from a personal computer's serial port. The transducer displays one of the following possibilities, depending on the type of card being mounted:

**PuL**: pulses for energy measurements only.

The number of pulses is set for each energy unit; the latter is defined by the type of totalized energy chosen in the "EnE" menu (Wh, VAh, VARh) and by the multiplier, which is identified by a blinking hyphen as for the "Lo.E" and "Hi.E" parameters. The choice to program the number of pulses for kWh (or kVAh or kVARh) or for MWh (or MVAh or MVARh) is made automatically by the transducer according to the installed power, if the latter is more than 2MW the pulses/energy become pulses for MWh (or MVAh or MVARh).

**AL**: alarm connected to the selected measurement. The selection of this measure depends on the choice made in the "AL" secondary menu according to the "**Selection / Measurement**" table on page 11.

**A.on**: value of the high alarm. This value can be set in accordance with the programmed Hi.E - Lo.E (electrical) input range; the maximum range is:  $-999 \leq A.on \leq 999$ .

**A.oF**: value of the low alarm. This value can be set in accordance with the programmed Hi.E - Lo.E (electrical) input range; the maximum range is:  $-999 \leq A.of \leq 999$ .

**dEL**: value expressed in seconds of the time delay at the alarm set-point's activation (ON). This value is to be programmed within the range:  $0 \leq dEL \leq 255$ ; it can be useful when it is necessary to avoid the alarm set-point's activation if the alarm duration is not long enough.

**Note.** The operating mode of the set-point is identified by the values of the set-point with reference to the following cases:

1.  $A.on > A.oF$ : the alarm occurs when the measured value is higher than "A.on". The hysteresis is given by the difference between "A.on" and "A.oF". The delay time starts when the measured variable goes over the programmed "A.on" value according to what has been already written for "dEL".
2.  $A.on = A.oF$ : the alarm occurs when the measured value is equal to "A.on". There isn't any hysteresis and the "dEL" delay time starts when the measured variable goes over the programmed "A.on" value according to what has been already written for "dEL".
3.  $A.on < A.oF$ : the alarm occurs when the measured value is lower than "A.on". The hysteresis is given by the difference between "A.oF" and "A.on". The "dEL" delay time starts when the measured variable goes under the programmed "A.on" value according to what has been already written for "dEL".

**Example 3:** if an alarm is to be activated when the power factor goes below  $\cos\phi$  0.75 inductive with an hysteresis equal to 0.1 and a delay of 20 seconds (according to what has been written for  $A.on > A.oF$ ), select



"r5" in the "AL" secondary menu and set the parameters as follows:

A.on = L.75, A.oF = L.85, dEL = 20.

**Example 4:** if an alarm is to be activated when the active power goes over 135kW, with an hysteresis equal to 8kW, and a delay of 10 seconds (according to what has been written for A.on > A.oF), then select "r1 in the "AL" secondary menu and set the parameters as follows:

A.on = 135, A.oF = 127, dEL = 10.

**FIL**: selection menu of the digital filter's parameters.

This function allows you to stabilize the value of the instantaneous measurement retransmitted by the transducer when the value is not stable enough from the beginning and will not therefore allow either a clear reading on the instruments connected to the output or a good control by the alarm set-point.

**Fi.S**: activation range of the digital filter.

This value is programmed within the range:  $0 \leq \text{Fi.S} \leq 99.9$ . The programmable numerical value represents the fluctuation range (ripple) of the value which has been measured and retransmitted by the transducer. In the first configuration phase this value must be equal to "0" and the right value is to be entered only after the verification of the possible fluctuation. The value of this parameter can be calculated by the below indicated formula or entered step by step after checking the output ripple. The formula to be used is the following:

$$\text{Ripple (\%)} = \frac{100.000}{\text{AFS} \times \text{FSO}} \times \Delta R \times \frac{(\text{Hi.E} - \text{Lo.E})}{(\text{Hi.A} - \text{Lo.A})}$$

where:

**AFS** = electrical full scale value "Hi.E" automatically calculated by the transducer;

**FSO** = maximum full scale of the analogue output (20mA, 10V, etc.);

**DR** = fluctuation of the analogue output value (mA or V);

**Hi.E** = maximum manually programmed electrical scale value;

**Lo.E** = minimum manually programmed electrical scale value.

If the Lo.E and Hi.E parameters have not been changed from the original (Lo.E = 0, Hi.E = AFS), the formula becomes:

$$\text{Ripple (\%)} = \frac{100.000}{\text{FSO} (\text{Hi.A} - \text{Lo.A})} \times \Delta R$$

**Note:** if the "Hi.E" parameter has been changed and the operator doesn't remember the original value (the one which is automatically calculated by the transducer) it can be displayed again by changing the actual "rEt" parameter with any other parameter, confirming the new selection (from r1 to r11) with the "S ●" key and subsequently entering the "rEt" secondary menu, this time selecting the desired measure. The value subsequently displayed by the "Hi.E" parameter will be the value automatically calculated by the transducer (AFS). Example: if the fluctuation of the analogue output is 0.5mA (ΔR), which is the ripple calculated to be entered as Fi.S value?

Considering:

AFS = 37.5 (kW), FSO = 20mA,

Hi.E = 28.0 (kW); Lo.E = 10.0 (kW), Hi.A = 99.9 (%), Lo.A = 20.0 (%)

the Ripple (%) becomes:  $\frac{100,000}{37.5 \times 20} \times 0.5 \times \frac{(28 - 10)}{(99.9 - 20)} = 15$  (%)

then, enter 15.0 as Fi.S value.

**Fi.C**: value of the filtering coefficient to be programmed within the range:  
 $1 \leq \text{Fi.C} \leq 255$ .

The higher is the "Fi.C" value, the higher the filtering of the measured value and the longer the updating of the analogue output/s and alarm set-point.

**Note**: for a correct working of the filter, the relevant coefficient must satisfy the following relationship:  $1 \leq \text{Fi.C} \leq (\text{Fi.S} \times 4) \leq 255$ .

**P.it**: selection menu of the active power integration time.

Every "t" minutes, the output is updated as an average calculation of the instantaneous active power measured during the latest time period (t). Setting of the integration time expressed in minutes. Programmable value:  $1 \leq t \leq 30$ .

**End**: exit from programming.

The exit from programming can occur also for time-out after approx. 20 seconds from the last operation. The display will then show only a blinking point (if it's not an alarm).

**Warning**. When the instrument exits from programming due to time-out, the last parameter which was being programmed will not be saved in the EEPROM memory.

**Note**. Displaying of numbers: the range of numbers which can be displayed by the transducer goes from -999 to +999 (except for the decimal point).

The negative numbers (which may be displayed for some parameters such as "Lo.E", "Hi.E", "A.on" and "A.oF") are identified by a blinking decimal point of the least significant digit.

### SptSoft

SptSoft is a software which can be used to easily load and unload the programming parameters from an SPT-90 to a PC and from a PC to a single SPT-90 or a series of them connected in a network.

The software can also be used to control the communication in the network itself.

To install the software insert disk N° 1 in the PC and from the "Start-up" menu of Windows select "Execute...". Then, type "A:\setup" in the command bar and then click on "OK" and carry out the instructions on the screen.

Once you run the software, the screen shows the main window of the programme (see figure on the following page) where it is possible to read and then modify the programming parameters of the instruments connected to the network.

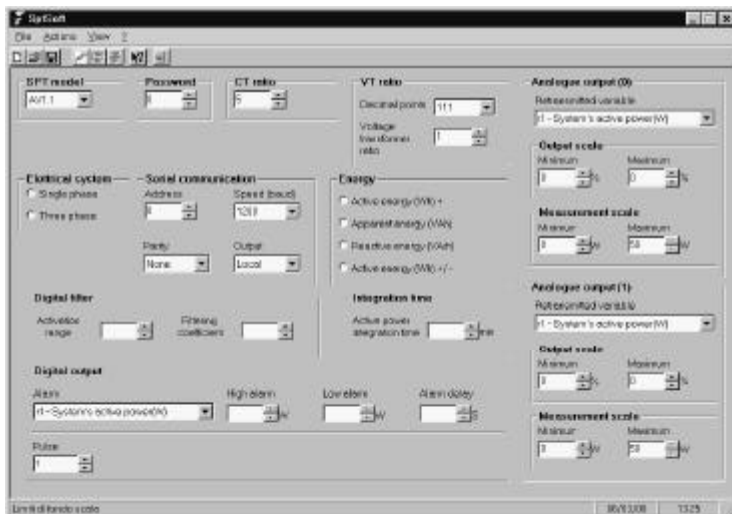

## ACCURACY INFORMATION

### WARNING

- The control of the analogue outputs is not guaranteed if:
- the overload conditions of the inputs ( $1.2 I_n/U_n$ ) are exceeded and
  - the "Sr" scale ratio is higher than 4.

Input	Star Voltage	Delta voltage	Current
AV1	Un: 100V/š3	Un: 100V	In: 1A
AV3	Un: 100V/š3	Un: 100V	In: 5A
AV4	Un: 250V	Un: 430V	In: 1A
AV5	Un: 250V	Un: 430V	In: 5A
AV7	Un: 400V	Un: 690V	In: 5A

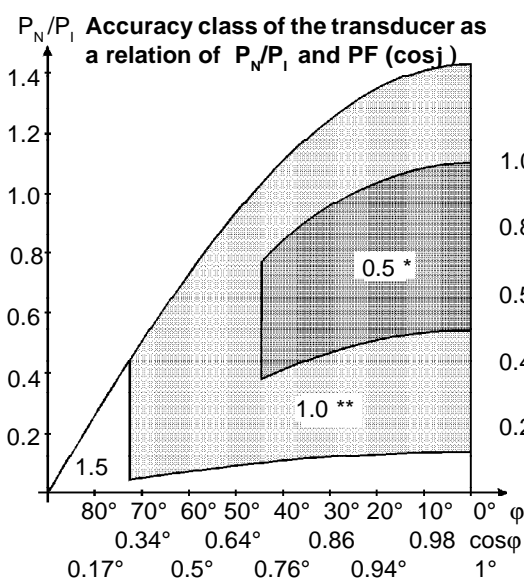

Trend of the E error depending on the  $S_R$  scale ratio

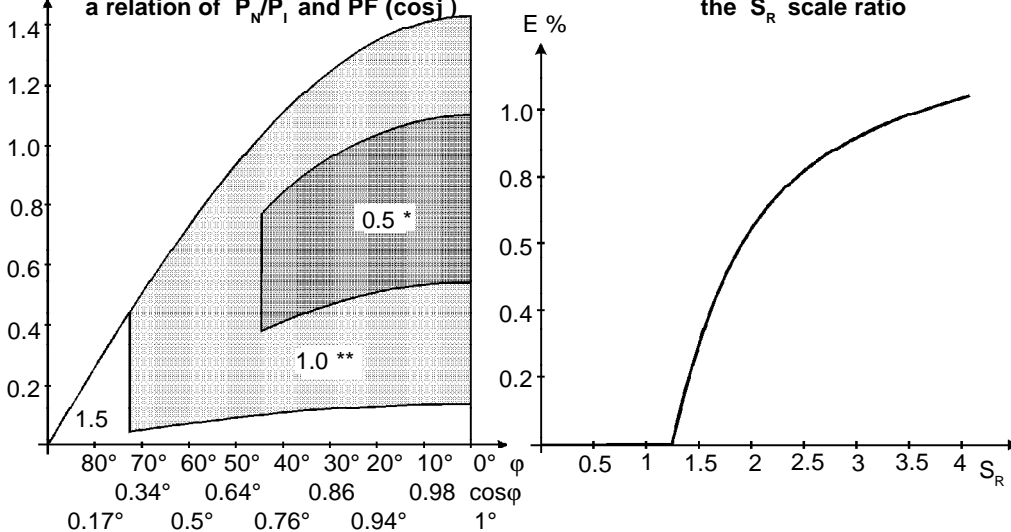

\*  $V = 0.9$  to  $1.1U_n$ ;  $I = 0.6$  to  $1I_n$ ;  $f = 48$  to  $62$  Hz

\*\*  $V = 0.7$  to  $1.2U_n$ ;  $I = 0.2$  to  $1.2I_n$ ;  $f = 48$  to  $100$  Hz

**P<sub>N</sub>** : $P_N = U_N \times I \times \text{PF} (\cos\varphi)$  (single-phase system); $P_N = \sqrt{3} \times U_N \times I \times \text{PF} (\cos\varphi)$  (three-phase, three-wire system); $P_N = 3 \times U_N \times I \times \text{PF} (\cos\varphi)$  (three-phase, four-wire system);

where:

 $U_N$  = the real phase-neutral voltage of the electrical system being measured; $I$  = the maximum phase current of the electrical system being measured;Power factor ( $\cos\varphi$ ) = the average power factor ( $\cos\varphi$ ) of the electrical system to be measured;**P<sub>I</sub>** : $P_I = U_I \times I_I \times \text{VT (ratio)} \times \text{CT (ratio)}$  (single-phase system); $P_I = \sqrt{3} \times U_I \times I_I \times \text{VT (ratio)} \times \text{CT (ratio)}$  (three-phase, three-wire system); $P_I = 3 \times U_I \times I_I \times \text{VT (ratio)} \times \text{CT (ratio)}$  (three-phase, four-wire system);

where:

 $U_I$  = rated input voltage of the transducer; it changes depending on the model (see table on page 19); $I_I$  = rated input current of the transducer; it changes depending on the model (see table on page 19);

VT (ratio) = the value of the voltage transformer ratio (P-S parameter in the "in.U" menu);

CT (ratio) = the rated value of the current transformer ratio (P-S parameter in the "in.C" menu);

**Example 5:**

model AV3.3 (3-wire system)

 $U_N = 6\text{kV}$  (Ø voltage) $I = 265\text{A}$  (single phase current) $\text{Cos}\varphi = 0.85$  (system's power factor) $U_I = 100\text{V}$ ; $I_I = 5\text{A}$  $\text{VT (ratio)} = \frac{6\text{kV}}{100\text{V}} = 60$  $\text{CT (ratio)} = \frac{300\text{A}}{5\text{A}} = 60$  $P_N$  becomes:  $\sqrt{3} \times U_N \times I \times \cos\varphi = \sqrt{3} \times 6000 \times 265 \times 0.85 = 2.33\text{MW}$  $P_I$  becomes:  $\sqrt{3} \times U_I \times I_I \times \text{VT (ratio)} \times \text{CT (ratio)} = \sqrt{3} \times 100 \times 5 \times 60 \times 60$  $= 3.12\text{MW}$ , the ratio  $\frac{P_N}{P_I}$  is:  $\frac{2.33}{3.12} = 0.75$ **Example 6:**

model AV3.3 (4-wire system)

 $U_N = 6\text{kV} / \sqrt{3}$ ; $I = 265\text{A}$ Power factor ( $\text{Cos}\varphi$ ) = 0.85 $U_I = 100\text{V} / \sqrt{3}$  $I_I = 5\text{A}$  $\text{VT (ratio)} = \frac{6\text{kV} / \sqrt{3}}{100\text{V} / \sqrt{3}} = 60$  $\text{CT (ratio)} = \frac{300\text{A}}{5\text{A}} = 60$

$P_N$  becomes:  $3 \times U_N \times I \times \cos\phi = 3 \times 6000 / \sqrt{3} \times 265 \times 0.85 = 2.33\text{MW}$   
 $P_I$  becomes:  $3 \times U_I \times I_I \times VT \text{ (ratio)} \times CT \text{ (ratio)} = 3 \times 100 / \sqrt{3} \times 5 \times 60 \times 60 = 3.12\text{MW}$ , the ratio  $\frac{P_N}{P_I}$  is: 0.75

In both examples the accuracy of the measurement is 0.5% F.S. when considering the amplitude range of the measured voltage from  $0.9U_n$  to  $1.1U_n$  and the amplitude range of the measured current from  $0.6I_n$  to  $1I_n$  with a PF ( $\cos\phi$ ) of 0.85 (according to the graph on page 19).

The accuracy of the output is connected to the accuracy of the measurement plus the scale ratio of both inputs (Hi.E - Lo.E) and outputs (Hi.A - Lo.A) as shown in the graph on page 19.

When:  $S_R = \frac{AFS \times (Hi.A - Lo.A)}{100 \times (Hi.E - Lo.E)} - 1.25$

where

AFS = automatically calculated electrical full scale value

$S_R$  = scale ratio.

There isn't any additional accuracy error on the output signal if  $S_R - 1.25$ .

**Example 7:**

AFS = 3.30MW; Lo.E = 0; Hi.E = 3.30MW; Lo.A = 20%; Hi.A = 99.9%

$S_R$  becomes:  $\frac{3.30 \times (99.9-20)}{100 \times (3.30-0)} = 0.8$

0.8 - 1.25 no additional error.

**Example 8:**

AFS = 3.30MW; Lo.E = 1.00MW; Hi.E = 3.00MW; Lo.A = 20%

Hi.A = 99.9%

$S_R$  becomes:  $\frac{3.30 \times (99.9-20)}{100 \times (3-1)} = 1.32$

1.32 > 1.25, according to the graph on page 19 there is an additional error of 0.2% F.S.

---

**USEFUL INFO**

---

The transducer is able to retransmit the measured current/power/energy according to the direction of the current flowing in the primary/secondary of the connected current transformer (if connected); see the figures below:

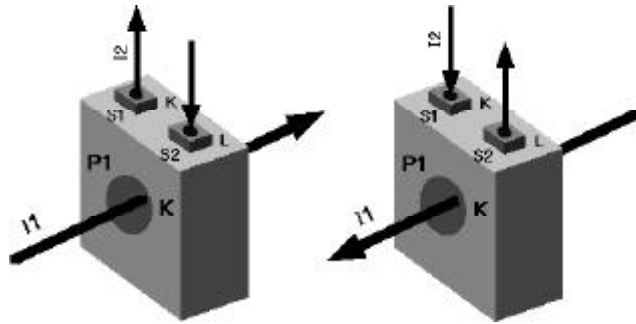

**It is very important to respect the polarity of the measuring inputs, otherwise the analogue outputs will not work properly.**

**A wrong connection of the current inputs will not allow the 0 to 20mA / 0 to 10V output to retransmit any signal.**

Anyway it is possible to measure and retransmit currents/powers in accordance with their flowing direction using the "Lo.A/Hi.A" and "Lo.E/Hi.E" parameters properly.

For example, it is necessary to measure a power up to 100kW taking into consideration that it can be consumed or generated by the system:

**Example 9:**

If the output signal is 0-20mA, the scaling parameters can be set as follows:

"Lo.E" must be 0(kW) and "Hi.E" must be 100(kW), therefore "Lo.A" is 50.0(%) (10mA) and "Hi.A" is 99.9(%) (20mA).

When the power is -100kW (generated power) the output is 0mA, when it is "0" the output current is 10mA and when the power is 100kW (consumed power) the output current is 20mA.

**Example 10:** if the output signal is  $\pm 10$ VDC, the scaling parameters can be set as:

"Lo.E" = -100(kW) and "Hi.E" = 100(kW), therefore "Lo.A" must be 0(%) 0V and "Hi.A" must be 99.9(%) (+10VCC), that means when the power is -100kW the output is -10V, when it is "0", the output is 0V and when the power is 100kW the output voltage is +10VCC.

## AVAILABLE MODULES:

### Analogue output modules

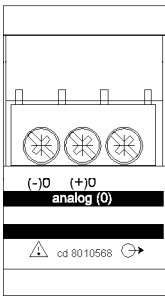

**AO1050** (20mADC)  
**AO1051** (10VDC)  
**AO1052** ( $\pm 5$ mADC)  
**AO1053** ( $\pm 10$ mADC)  
**AO1054** ( $\pm 20$ mADC)  
**AO1055** ( $\pm 1$ VDC)  
**AO1056** ( $\pm 5$ VDC)  
**AO1057** ( $\pm 10$ VDC)

Single output

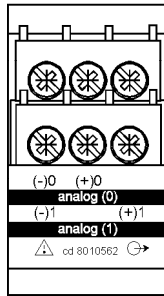

**AO1026** (20mADC)  
**AO1027** (10VDC)  
**AO1028** ( $\pm 5$ mADC)  
**AO1029** ( $\pm 10$ mADC)  
**AO1030** ( $\pm 20$ mADC)  
**AO1031** ( $\pm 1$ VDC)  
**AO1032** ( $\pm 5$ VDC)  
**AO1033** ( $\pm 10$ VDC)

Dual output

### Digital output modules

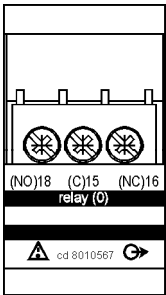

**AO1058**  
 Single relay  
 output

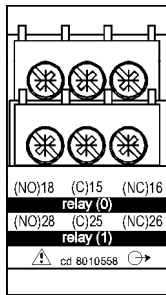

**AO1035**  
 Dual relay  
 output

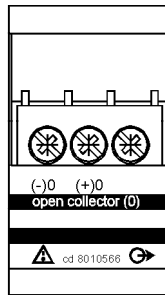

**AO1059**  
 Single open  
 collector output

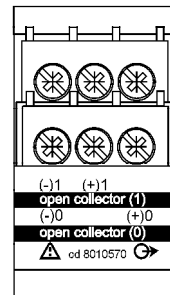

**AO1036**  
 Dual open  
 collector output

### Other input/output modules

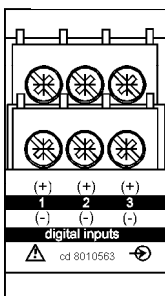

**AQ1038**  
 3 digital in-

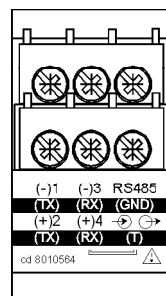

**AR1034**  
 RS485 output

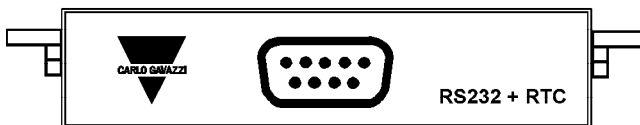

**AR1039**  
 RS232 output

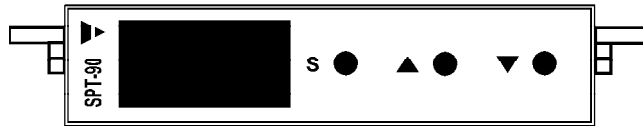

**AR1017**  
Programming unit

**Power supply modules**

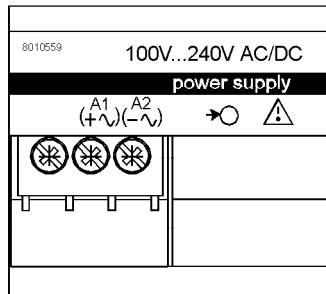

**AP1020**  
90 - 260 VAC/DC power supply

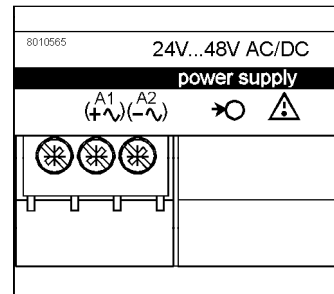

**AP1021**  
18 - 60 VAC/DC power supply